

Grazie per aver scelto il nostro prodotto.

Si prega di leggere attentamente il presente manuale prima di iniziare qualsiasi attività.

Il presente manuale deve essere conservato per l'intera vita del prodotto.

Le informazioni contenute in questo manuale sono corrette al momento della scrittura. Le illustrazioni, le foto ed i colori forniti hanno il solo scopo di facilitare il montaggio e non sono in alcun modo vincolanti. L'azienda si riserva il diritto di apportare modifiche parziali o complete in qualsiasi momento senza preavviso ai clienti.

Il prodotto è destinato all'uso privato, escluso l'uso di abitazioni o attività commerciali. È un prodotto tipico da giardino. Le cassette estive possono essere utilizzate per immagazzinare qualsiasi oggetto resistente ai cambiamenti di umidità, mobili da giardino o attrezzi da giardino.

STOCCAGGIO DEGLI ELEMENTI:

1. Si raccomanda di non spacchettare la confezione se il prodotto non verrà montato entro le 72 ore successive.
2. A temperature estremamente elevate superiori a 25°C, si consiglia di installarlo entro 24 ore dall'apertura.



3. Quando la confezione viene spacchettata, gli elementi devono essere conservati su una superficie piana, sotto un tetto al riparo di agenti atmosferici, in un luogo asciutto e arieggiato, in modo che non si deformino e siano protetti dagli agenti atmosferici senza contatto con il suolo (non conservare gli elementi in un locale riscaldato o in un luogo con forte irraggiamento solare).
4. Si consiglia di appesantire gli elementi non imballati per tutta la loro lunghezza.
5. Se il prodotto viene conservato all'aperto, lasciare una pellicola protettiva
6. L'imballaggio del prodotto deve essere smaltito secondo le norme vigenti.
7. L'imballaggio non può essere utilizzato per divertimento. Deve essere tenuto fuori dalla portata dei bambini, poiché esiste il rischio di provocare un incidente (ad es. scivolare sulla pellicola, soffocamento, ingestione di piccole parti, ecc.)
8. Se per qualsiasi motivo l'installazione dovesse essere interrotta nel corso del tempo, proteggere la piscina e le altre parti non installate, da condizioni atmosferiche avverse. In caso contrario, il produttore non sarà responsabile per eventuali danni causati.



PRIMA DEL MONTAGGIO:

1. Verificare che tutti gli elementi necessari siano inclusi nel pacchetto secondo l'elenco degli elementi in allegato
2. In caso di discrepanze o difetti, si prega di contattare il venditore prima di iniziare il montaggio, ma non oltre 14 giorni dalla data di consegna.
3. Per presentare un reclamo, compilare il modulo di reclamo allegato in modo leggibile inserendo:
 - dati dell'Acquirente
 - descrizione dei difetti + le loro foto
 - numero e quantità di articoli mancanti
 - numero unico del pacco sull'etichetta

ATTENZIONE:

In caso di assenza delle informazioni di cui sopra, il reclamo non sarà preso in considerazione.

4. Se acquisti direttamente dal negozio Altanka, o tramite una piattaforma di vendita, il i dati di cui sopra devono essere inseriti nel nostro pannello post-vendita, disponibile all'indirizzo del sito web: <https://sav.altanka.com.pl>



COME TROVARE IL NUMERO DEL PACCO



L'etichetta con il numero del pacco è attaccata anche al pallet.

I documenti si trovano appena sotto l'imballo, sugli elementi in legno.

Kod. i. B. i.	Opis i. specyfikacja	Ilość (szt. / metr. b.)		quant. (m³)	
1		40	77	2600	2
2		48	48	2600	15
3		40	145	2600	2
4		40	126	2600	2
5		40	145	265	28
6		40	145	3800	30
7		40	145	4000	2
8		40	145	2500	1
9		40	145	2000	3
10		45	673	4000	2
11		38	846	1830	1
12		38	846	1830	1
13		38	846	1830	1
14		16	70	1700	1
15		15	59	1600	25
16		15	59	2970	25
17		15	59	3042	2
18		15	59	3008	2
19		15	59	1556	2
20		15	59	1516	2
21		15	59	200	2
22		13	22	1130	23
23		10	70	2600	3
24		3	100	2800	6
25					2



Numero del pacco.



Lo stesso numero di pacco è ripetuto anche sui documenti con l'elenco degli elementi.

5. Scegliere attentamente il luogo in cui deve essere posizionato il prodotto

NOTA:

Il prodotto non deve essere installato sotto linee elettriche, sopra le installazioni di terra come elettricità, acqua, gas, dove potrebbe essere necessario l'accesso, e in luoghi in cui tale carico non è previsto. Il prodotto deve essere installato in un luogo in cui non sarà esposto a contatto costante con l'acqua (incluso un sistema di irrigazione).

Il montaggio deve essere eseguita su una superficie uniforme e indurita. Gli elementi in legno non possono avere un contatto diretto con il suolo (usa elementi isolanti, ad es. feltro catramato + travetti - se il tuo modello non li ha nel set, acquistali tu stesso)

6. Verificare con l'ufficio corrispondente al Tuo luogo di residenza, quali regolamenti edilizi si applicano al prodotto da Te acquistato.
7. Eseguire i lavori di fondazione secondo le linee guida contenute in questo manuale. Ricordare che la preparazione delle fondamenta deve essere eseguita in conformità con le pratiche di costruzione (pianificare il tempo necessario per far asciugare il calcestruzzo!)
8. La lastra di cemento deve avere uno spessore minimo di 10 cm e deve essere adattata al terreno.
9. La dimensione della lastra in cemento deve corrispondere alle dimensioni del prodotto (vedere disegno di riferimento).
10. Assicurarsi che le fondamenta siano ben isolate, stabili e livellate
11. Acquistare la quantità necessaria di impregnante (vedi il manuale - per i prodotti non impregnati) e proteggere tutti gli elementi in legno secondo le raccomandazioni del produttore dell'impregnante. Si consiglia di verniciare la casa dopo il montaggio. Se la casa viene dipinta in autunno, nel periodo di calore estremo, ci possono essere luoghi non verniciati che devono essere dipinti. Se gli elementi vengono dipinti prima del montaggio, essi devono essere conservati per l'asciugatura su una superficie piana, protetti da fattori esterni in modo da evitare deformazioni.
12. Si raccomanda l'installazione di grondaie.
13. Nei luoghi in cui è previsto il montaggio con viti, si consiglia di preforare i fori utilizzando un trapano con un diametro inferiore alla dimensione della vite di Ø1.

IL MONTAGGIO:

1. Scegliere una giornata calda e soleggiata. I prodotti in legno devono essere installati nell'intervallo di temperatura di 10-25°C. Evitare forti gelate e calore.
2. Durante i lavori, osservare le regole di sicurezza generalmente accettate
3. Installazione di dormienti e pavimenti (pavimento per un costo aggiuntivo):
 - il pavimento può essere in una versione universale in pacchetti di 3 m² o essere costituito da soppalchi già pronti
 - durante l'installazione del pavimento, seguire sempre le istruzioni di installazione del pavimento in allegato
 - ricordare di isolarlo correttamente a terra e drenare l'acqua.
4. Montaggio delle pareti:

ATTENZIONE: ricordare che elementi correttamente livellati formeranno la base dell'intero prodotto, il loro assemblaggio appropriato influenzerà l'intera durata del prodotto

ATTENZIONE: non esercitare una pressione diretta sulle parti durante il montaggio - ciò potrebbe danneggiare un elemento. Utilizzare un martello di gomma e una tavola

aggiuntiva allegata. La garanzia del produttore non copre i danni meccanici causati da un montaggio improprio o durante l'uso.



RICORDA: il legno è un materiale naturale, quindi possono essere presenti elementi contorti. Durante il loro montaggio, seguire le istruzioni di seguito:

- piano la disposizione degli elementi ritorti in punti diversi per adattarli al meglio alla struttura



- nel caso di tavole attorcigliate cercare di posizionare gli elementi più attorcigliati nella parte inferiore della struttura



Strumenti e materiali che il cliente dovrebbe acquistare:

- A- tavole di sicurezza (incluse)
- B- strisce per incastrare (inclusa)
- C- morsetti per carpenteria
- D- martello di gomma

Operazioni:

1. posizionare le tavole sul lato come mostrato in figura
2. stringere con morsetti
3. incastrare l'elemento attraverso la tavola B con aiuto del martello di gomma D

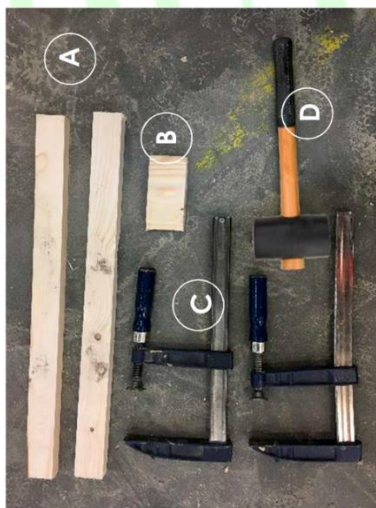
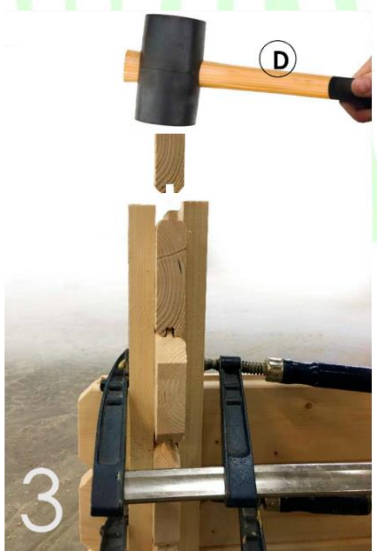
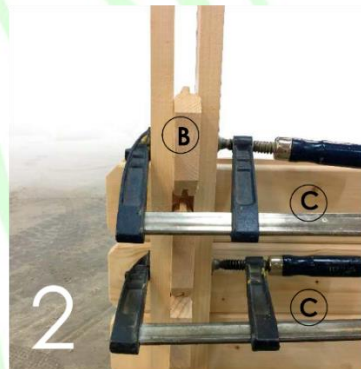
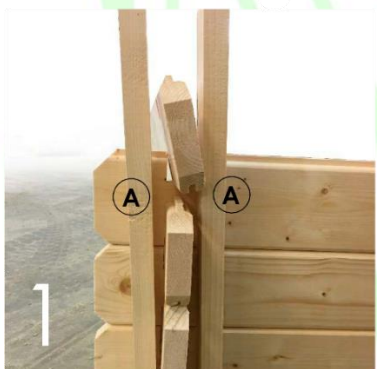

- **IMPORTANTE!!!** assicurarsi che la linguetta sia sempre rivolta verso l'alto!



- dopo aver controllato le diagonali del primo strato di tavole (devono sempre avere la stessa lunghezza), è possibile installare ulteriori strati

- ricordare di ancorare correttamente il prodotto a terra (ad es. usando angoli, barre piatte, ecc.)

5. Installazione di porte e finestre:

- prima di installare la falegnameria, controllare la verticale e il livello delle pareti per consentire il loro corretto assemblaggio e ulteriore funzionamento

- seguire sempre le istruzioni del manuale

- prima di assemblare il plexiglass, rimuovere la pellicola protettiva

- i listelli e le inglesine sono pre-tagliati, prima del montaggio ordinare e abbinare le dimensioni dell'apertura nella porta e nella finestra. Se è necessario, tagliare i listelli con attenzione. I chiodi di montaggio devono essere martellati con un martello per tappezzeria piccolo a una distanza di almeno 30 mm dall'estremità.

6. Installazione del tetto a capanna:

ATTENZIONE! Usa una scala per montare il tetto. Non andare sul tetto!

L'accesso al tetto è consentito con riserva durante l'installazione del feltro bitumato/tegola bituminosa e solo quando il tetto è completamente installato, ricordandosi di rispettare il carico massimo del tetto.

- Si raccomanda di fissare le trave secondo il disegno sottostante



- posizionando le tavole del tetto, ricordarsi di lasciare uno spazio di 1-2 mm tra le tavole, che faciliterà il lavoro del legno e non causerà rigonfiamenti durante l'alta umidità

- modalità del fissaggio delle tavole del tetto



ATTENZIONE: il carico massimo sul tetto è di 25 kg / m². Neve, ghiaccio, foglie, ecc. devono essere rimosse sistematicamente.

7. Installazione del tetto a falde:

ATTENZIONE! Usa una scala per montare il tetto. Non andare sul tetto!

L'accesso al tetto è consentito con riserva durante l'installazione del feltro bitumato/tegola bituminosa e solo quando il tetto è completamente installato, ricordandosi di rispettare il carico massimo del tetto.

- La trave deve essere fissata in cima secondo il disegno sottostante



- posizionando le tavole del tetto, ricordarsi di lasciare uno spazio di 1-2 mm tra le tavole, che faciliterà il lavoro del legno e non causerà rigonfiamenti durante l'alta umidità

- modalità del fissaggio delle tavole del tetto



ATTENZIONE: il carico massimo sul tetto è di 25 kg / m². Neve, ghiaccio, foglie, ecc. devono essere rimosse sistematicamente.

8. Copertura del tetto:

- il tetto della casa deve essere coperto immediatamente dopo aver finito il montaggio
- i fogli del cartone catramato devono sovrapporsi come indicato nel manuale
- in caso di danneggiamento del cartone catramato, sostituire il pezzo danneggiato con uno nuovo
- è possibile sostituire il cartonfeltro bitumato con tegola bituminosa o altro materiale leggero, tenendo presente il carico massimo di 25 kg / m² e garantire la tenuta

9. Installazione di doghe anti-tempesta:

- fissando le barre anti-tempesta, praticare un foro di 6 mm nella parte superiore della casa e montarle secondo il disegno. Stringere a mano il bullone di bloccaggio, questo farà sì che il bullone si muova liberamente nell'apertura ovale durante il "lavoro" della parete di legno. Fissare il fondo della stecca con una vite.



DURANTE L'UTILIZZO:

1. Ricordare che la manutenzione regolare del legno e la rimozione sistematica dei rifiuti dall'area del prodotto sono indispensabili. Si prega di notare che un prodotto acquistato in versione non impregnata deve essere immediatamente protetto. Si consiglia di rinfrescare l'impregnante una volta all'anno. **ATTENZIONE!** Per mantenere la garanzia, conservare le ricevute di vendita dell'impregnazione.
2. Utilizzare prodotti di alta qualità per proteggere il legno.
3. Almeno una volta l'anno controllare le condizioni tecniche del prodotto:
 - prestare attenzione alla tenuta del rivestimento del tetto, se necessario sostituire il cartone catramato del tetto con uno nuovo
 - controllare che il prodotto sia sufficientemente ventilato (se necessario, installare le griglie di ventilazione per evitare il formarsi dell'umidità)
 - verificare il funzionamento delle parti mobili (porte, finestre)
 - lubrificare la serratura e le cerniere

4. In inverno, rimuovere sistematicamente la neve dal tetto. Non permettere che il carico sul tetto superi i 25 kg / m².
5. Prendere sempre cura della pulizia all'interno e all'esterno del prodotto acquistato. Ricordare che foglie, rami, erba o acqua stagnante possono contribuire a un rapido degradamento del legno.
6. Non agganciare o torcere insieme le tavole delle parete poiché ciò impedirebbe al legno di lavorare. Un'eccezione può essere rappresentata dai modelli di case con una costruzione speciale, dove è indicato nelle istruzioni di montaggio.
7. Non appendere gli armadi alle pareti, non avvitare gli scaffali.
8. Lasciare spazio sotto il tetto per la ventilazione e i lavori di falegnameria.

GARANZIA:

Il legno è un materiale vivo, quindi la cosa naturale è che lavora con i cambiamenti di temperatura e umidità. Sebbene attribuiamo grande importanza alla qualità del legno utilizzato nei nostri prodotti, non possiamo evitare alcuni dei fenomeni naturali presentati di seguito, che non sono coperti dalla garanzia:

caratteristica naturale del legno	Immagine	Indicazioni
cambiamenti di colore nel tempo, scolorimento o differenze di colore e struttura		Utilizzare i preparati disponibili per l'impregnamento del legno secondo le istruzioni del produttore.
tutti i nodi fino a 2 cm di diametro, così come i nodi naturali, sani (con colore scuro o pallido) sopra i 2 cm		È possibile usare un mastice per legno o silicone.
fessure		È possibile usare un mastice per legno o silicone. Le fessure hanno una natura stagionale, lavorano con i cambiamenti di umidità.

necrosi laterale		È possibile usare un mastice per legno o silicone
bolle di resina fuoriuscite di resina		Le fuoriuscite secche possono essere eliminate con uno strumento appuntito, facendo attenzione a non danneggiare la struttura del legno.
fioriture resinose		Per la rimozione è possibile utilizzare un solvente a base di acetone, trementina o benzina. Dopo la lisciviazione, lavare più volte con acqua tiepida e una piccola quantità di acido acetico.
macchia blu		Utilizzare preparati disponibili in commercio per rimuovere la macchia blu secondo le istruzioni del produttore.
muffa superficiale		Utilizzare preparazioni disponibili in commercio per rimuovere la muffa superficiale di legno in base alle istruzioni del produttore.

La garanzia copre (valida solo con la prova di acquisto):

1. Protezione del legno di 2 anni contro insetti (escluse termiti, formiche e api australiane) e funghi se sono soddisfatte le seguenti condizioni:

- il prodotto acquistato in versione non impregnata è stato impregnato con agenti generalmente disponibili come impregnanti, protezioni antimacchia, ecc. entro e non oltre la data dell'assemblea
- il legno non ha contatto diretto con terra e acqua (incluso anche un sistema di irrigazione)
- il legno viene trattato ogni anno con agenti impregnanti, protezioni antimacchia, ecc. disponibili in commercio.

NOTA: senza il trattamento annuale della struttura in legno, la garanzia scade. Ricordati di conservare la prova d'acquisto.

2. difetti di fabbrica ed elementi mancanti nel caso di ferramenta - 1 anno (garanzia valida solo prima del montaggio) - la garanzia è limitata alla sostituzione degli articoli difettosi, esclusa la riparazione di qualsiasi altro danno causato dallo stesso elemento difettoso.
3. difetti di fabbrica e elementi strutturali mancanti (garanzia valida solo prima del montaggio) - la garanzia è limitata alla sostituzione degli articoli difettosi, esclusa la riparazione di qualsiasi altro danno causato dall'elemento difettoso.
4. garanzia valida solo nel paese in cui è stato effettuato l'acquisto
5. la garanzia non è valida in caso di modifiche indipendenti al prodotto.
6. gli interventi sotto garanzia non prolungano la durata della garanzia stessa.

La garanzia non copre:

- le caratteristiche naturali del legno sopra indicate
- deformazioni naturali, ad esempio causate da un'esposizione prolungata al sole
- distorsioni e deformazioni durante il montaggio
- danni e difetti causati da errato trasporto, conservazione, installazione, uso e/o mancata manutenzione
- corrosione di elementi metallici
- elementi incollati
- danni derivanti dalla scarsa preparazione dell'area
- danni derivanti dall'intervento di persone non autorizzate
- danni causati dall'uso per scopi pubblici o commerciali
- danni causati da forze esterne come terremoti, incendi, frane, alluvioni, vento, tempesta, grandine e altre precipitazioni e fenomeni atmosferici
- danni causati da termiti, formiche o api australiane
- difetti visibili che l'acquirente dovrebbe notare al momento della consegna
- costi del lavoro, costi di trasporto, ecc. (rimangono a carico dell'acquirente)
- danni causati da allagamenti, infiltrazioni (anche dovuti ad errata installazione del tetto)

CARATTERISTICHE TECNICHE DEL LEGNO

Nota:

Il legno è un materiale vivo, quindi è naturale che funzioni con l'umidità e la temperatura. Sebbene diamo grande importanza alla qualità del legno utilizzato nei nostri prodotti, non possiamo evitare alcuni fenomeni che costituiscono le caratteristiche naturali del legno: cambiamenti di colore, nodi naturali, crepe, corteccia tra la corteccia, resina, colate di resina, sale, brunitura, muffe superficiali o curvature che non impediscono l'assemblaggio.

Tenendo conto della lavorazione permanente del legno, le dimensioni comunicate sono solo indicative (possono variare da ± 2 al 12% a seconda della sezione trasversale e della direzione misurata).

Va inoltre ricordato che il legno non è un materiale ermetico, impermeabile, ed è anche caratterizzato da un'elevata igroscopicità, pertanto, in caso di forti precipitazioni o di elevata umidità dell'aria, esiste il rischio di penetrazione dell'acqua.

Per ridurre al minimo l'assorbimento del legno possono essere utilizzati preparati speciali, ad esempio oli per impregnazione con cera.

Negli edifici residenziali o nelle case da giardino, dove ci preoccupiamo della tenuta, puoi inoltre riempire gli spazi vuoti con geotessile, lana minerale o inserti in gomma e lana, anche riempimenti sintetici, ad esempio silicone o massa per sigillare materiali in legno, adatti anche per fissare i collegamenti, ad esempio negli angoli della casa.

ATTENZIONE: i lavori aggiuntivi, come la sigillatura, vengono eseguiti da soli e a proprio rischio. Seguire sempre le raccomandazioni del produttore. Si ricorda che la sigillatura del prodotto prevede anche l'utilizzo di un'adeguata ventilazione.

Alcuni degli elementi che utilizziamo sono finger-joint. Tale legno è più resistente del legno massiccio e meno suscettibile a torsioni e deformazioni.

Altany

ALT21-1 300x300



ALT22-1 400x300



ALT24-1 400x400



ALT23-1 500x300



ALT23-1 500x400



ALT21-1 300x300

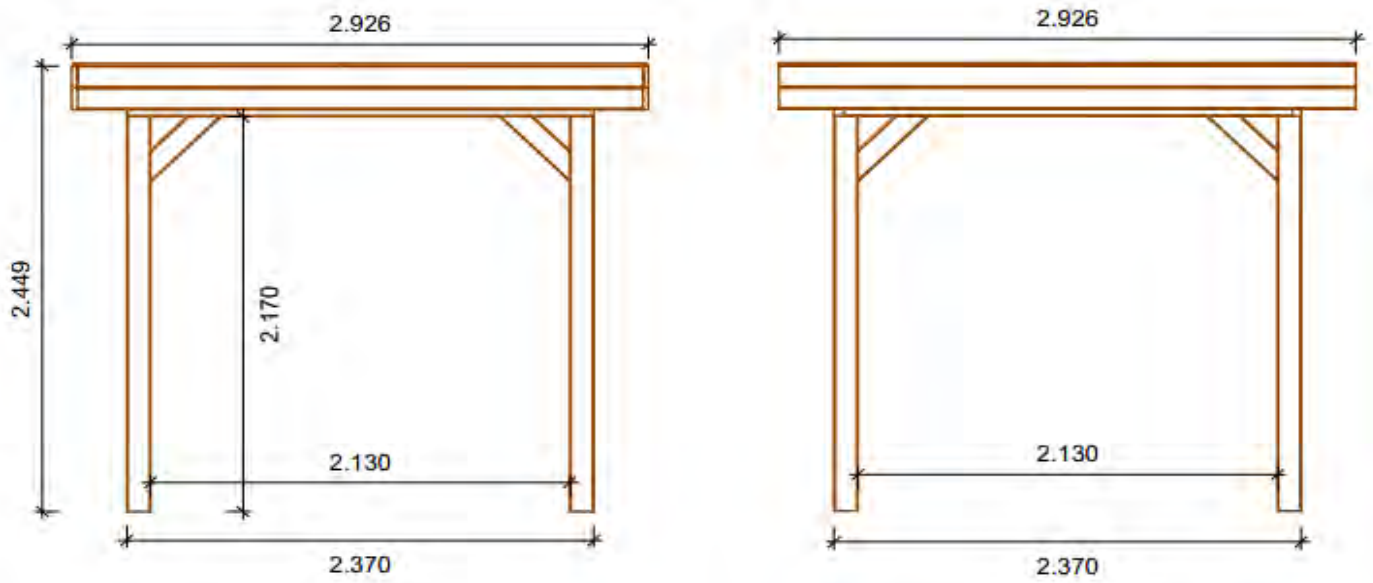

ALT22-1 400x300

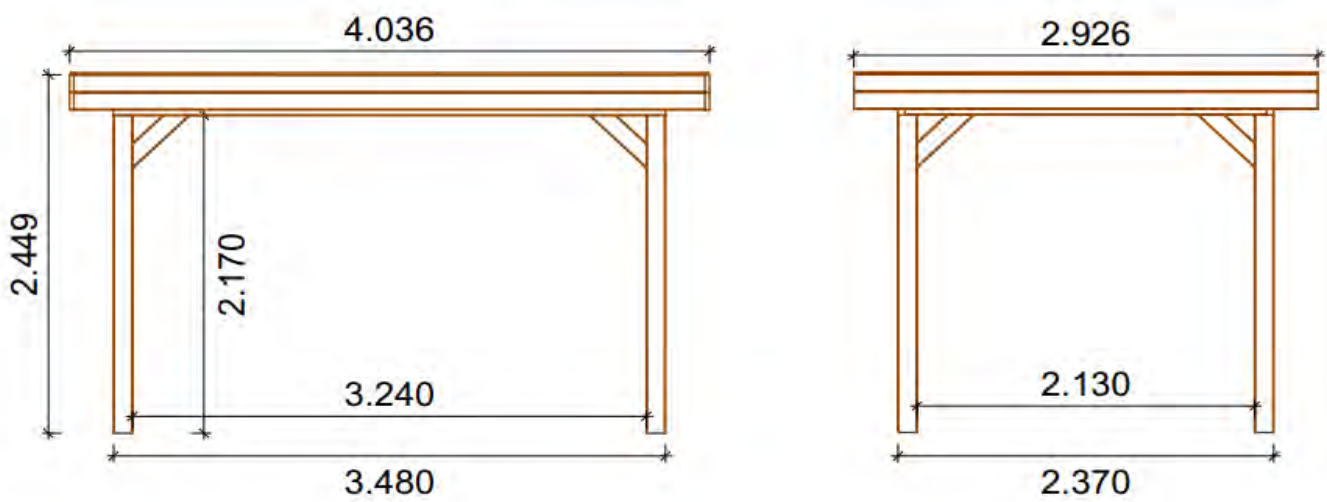

ALT23-1 500x300

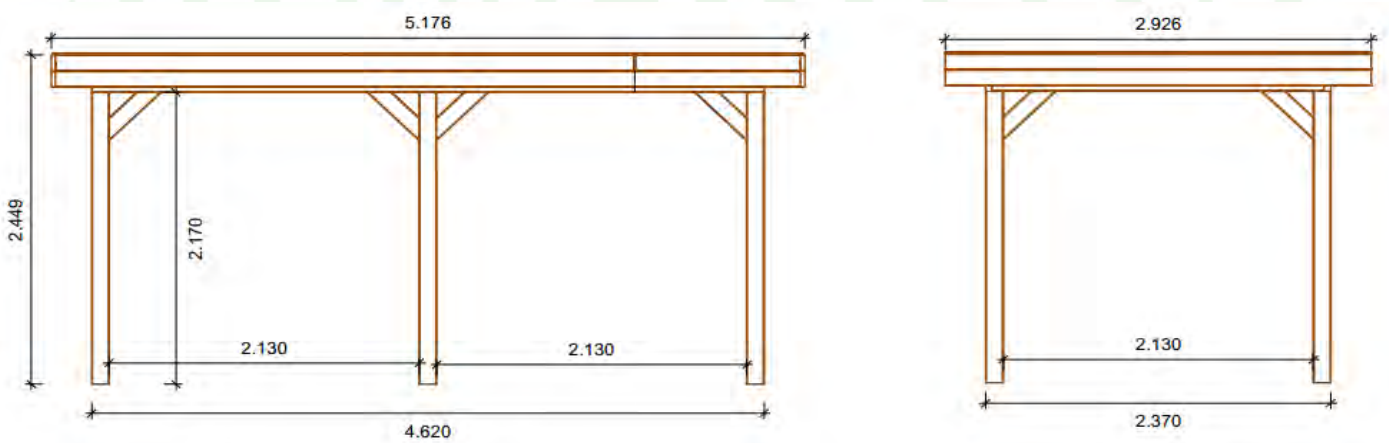



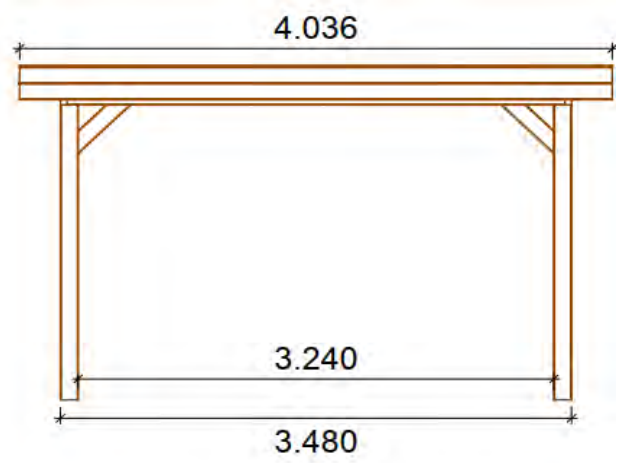
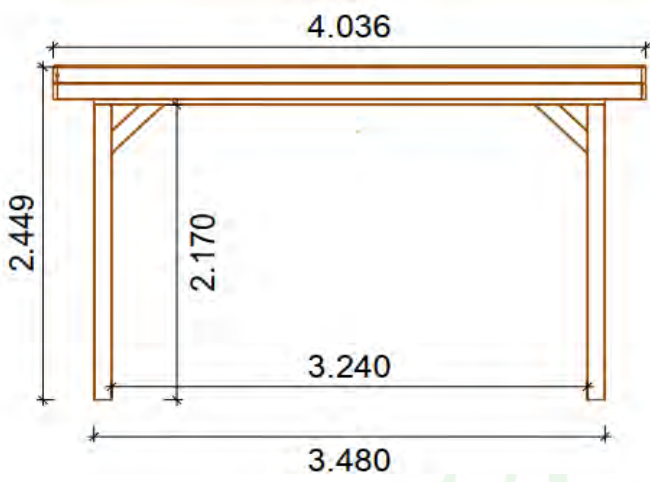



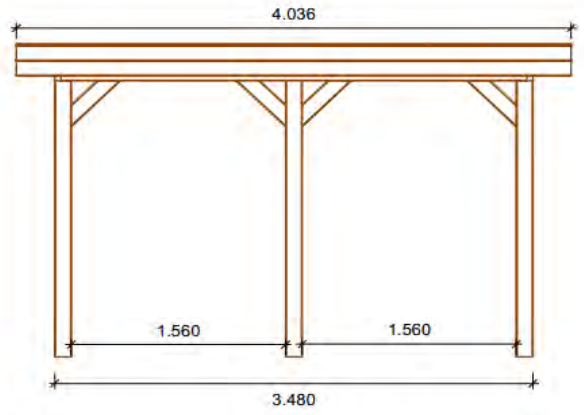
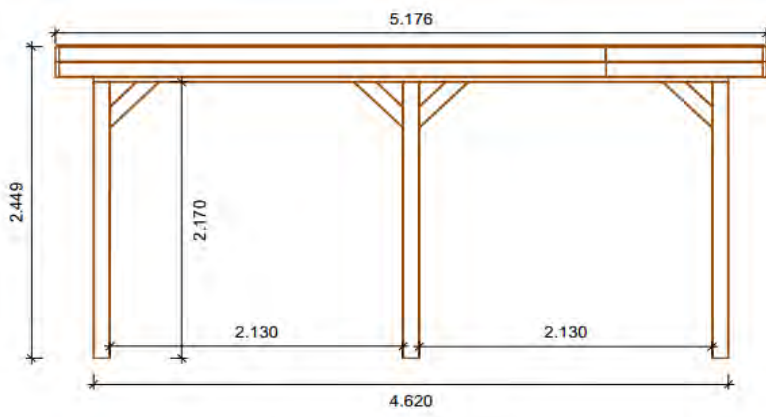













ALT24-1 400x400













ALT25-1 500x400



































ALT21-1 300x300

nr	Element	Size (mm)			pcs	miss	dama- ged
		d	h	L			
1		120	120	2270	4		
3		120	120	550	4		
4		120	120	550	4		
5	 	45	145	2370	2		
6	 	45	145	2280	2		
7	 	45	145	2870	5		
8		45	145	370	8		
9	 	16	99	2870	33		
10	 	28	120	2926	4		
11	 	28	120	2870	4		
12	 	19	19	1150	12		
13	 	13	19	1150	12		
14		0,8	3100	3100	1		























nr	Element	Size	pcs	miss	dam.
A		3,0x30	96		
B		4,0x50	72		
C		5,0x80	16		
D		5,0x100	56		
E		6,0x160	18		
F		2,0x40	175		
G			1		
H		Ø75	1		
J		2000	1		
K		Ø80	2		
L		Ø80	1		











ALT22-1 400x300

nr	Element	Size (mm)			pcs	miss	dama- ged
		d	h	L			
1		120	120	2270	4		
3		120	120	550	4		
4		120	120	550	4		
5	 	45	145	3480	2		
6	 	45	145	2280	2		
7	 	45	145	2870	7		
8		45	145	370	8		
9	 	16	99	1990	66		
10	 	28	115	2926	4		
11	 	28	115	3980	4		
12	 	19	19	1150	14		
13	 	13	19	1150	14		
14		0,8	3100	4200	1		





















nr	Element	Size	pcs	miss	dam.
A		3,0x30	112		
B		4,0x50	84		
C		5,0x80	16		
D		5,0x100	60		
E		6,0x160	22		
F		2,0x40	406		
G			2		
H		Ø75	1		
J		2000	1		
K		Ø80	2		
L		Ø80	1		





ALT23-1 500x300

nr	Element	Size (mm)			pcs	miss	dama- ged
		d	h	L			
1		120	120	2270	4		
2		120	120	2230	2		
3		120	120	550	6		
4		120	120	550	6		
5	 	45	145	4620	2		
6	 	45	145	2280	2		
7	 	45	145	2870	9		
8		45	145	370	8		
9	 	16	99	2560	66		
10	 	28	120	2926	4		
11	 	28	120	2560	8		
12	 	19	19	1150	16		
13	 	13	19	1150	16		
14		0,8	3100	5350	1		

















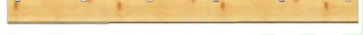



nr	Element	Size	pcs	miss	dam.
A		3,0x30	128		
B		4,0x50	96		
C		5,0x80	24		
D		5,0x100	72		
E		6,0x160	26		
F		2,0x40	538		
G			2		
H		Ø75	1		
J		2000	1		
K		Ø80	2		
L		Ø80	1		

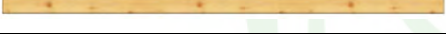









ALT24-1 400x400

nr	Element	Size (mm)			pcs	miss	dama- ged
		d	h	L			
1		120	120	2270	4		
3		120	120	550	4		
4		120	120	550	4		
5	 	45	145	3480	2		
6	 	45	145	3390	2		
7	 	45	145	3980	7		
8		45	145	370	12		
9	 	16	99	1990	90		
10	 	28	120	4036	4		
11	 	28	120	3980	4		
12	 	19	19	1150	16		
13	 	13	19	1150	16		
14		0,8	4200	4200	1		

nr	Element	Size	pcs	miss	dam.
A		3,0x30	128		
B		4,0x50	96		
C		5,0x80	16		
D		5,0x100	68		
E		6,0x160	26		
F		2,0x40	550		
G			2		
H		75	1		
J		2000	1		
K		80	2		
L		80	1		

ALT25-1 500x300

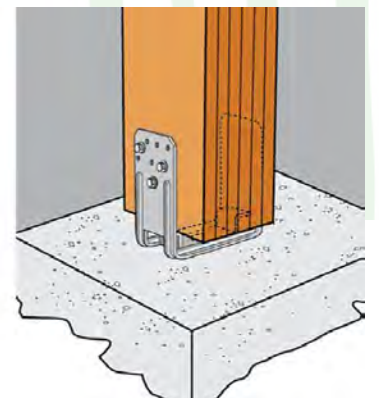
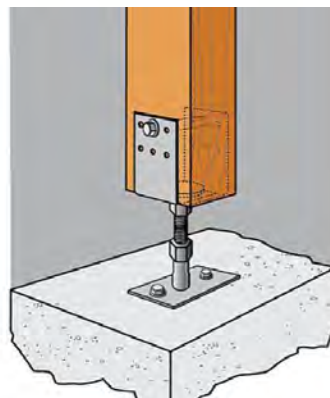
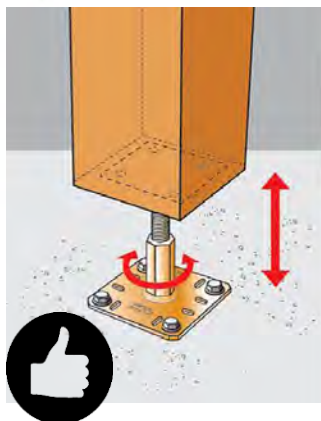
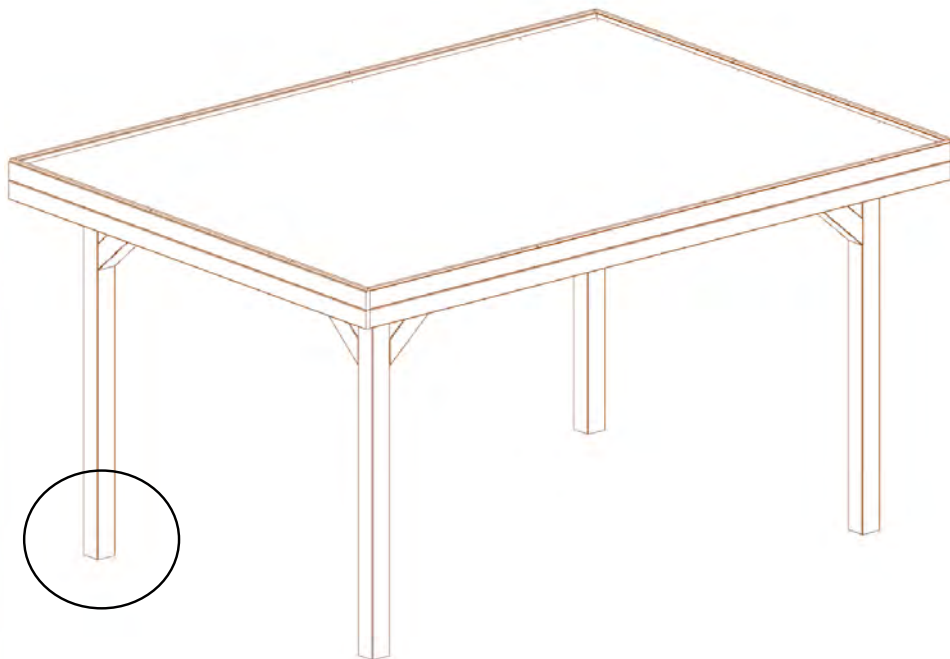
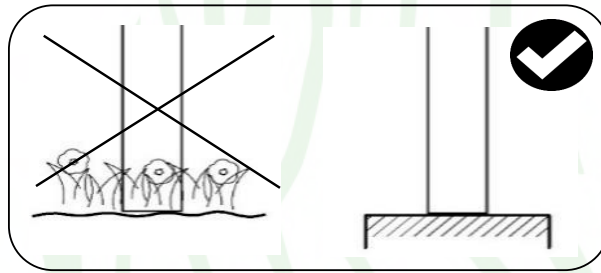
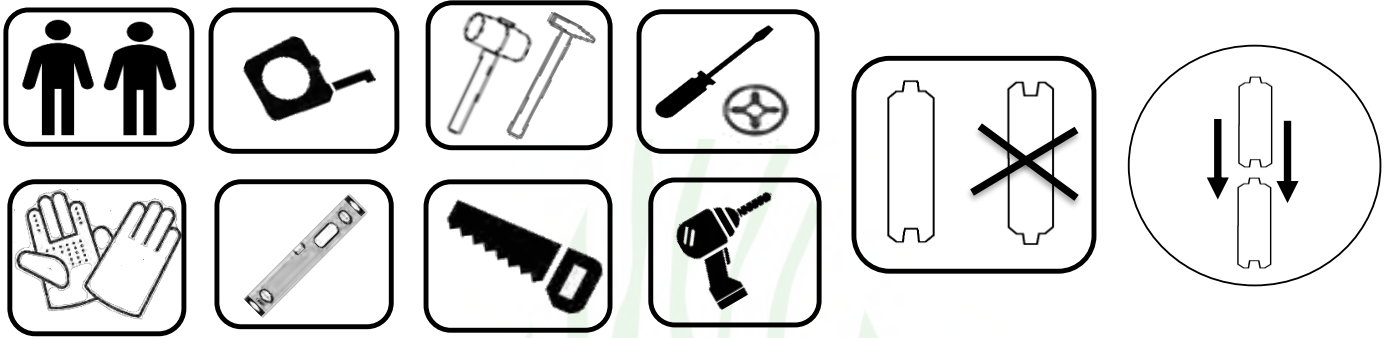

nr	Element	Size (mm)			pcs	miss	dama- ged
		d	h	L			
1		120	120	2270	4		
2		120	120	2230	2		
3		120	120	550	6		
4		120	120	550	6		
5	 	45	145	4620	2		
6	 	45	145	3390	2		
7	 	45	145	3980	9		
8		45	145	370	12		
9	 	16	99	2560	90		
10	 	28	115	4036	4		
11	 	28	115	2560	8		
12	 	19	19	1150	18		
13	 	13	19	1150	18		
14		0,8	4200	5350	1		

nr	Element	Size	pcs	miss	dam.
A		3,0x30	144		
B		4,0x50	108		
C		5,0x80	24		
D		5,0x100	92		
E		6,0x160	30		
F		2,0x40	730		
G			2		
H		Ø75	1		
J		2000	1		
K		Ø80	2		
L		Ø80	1		



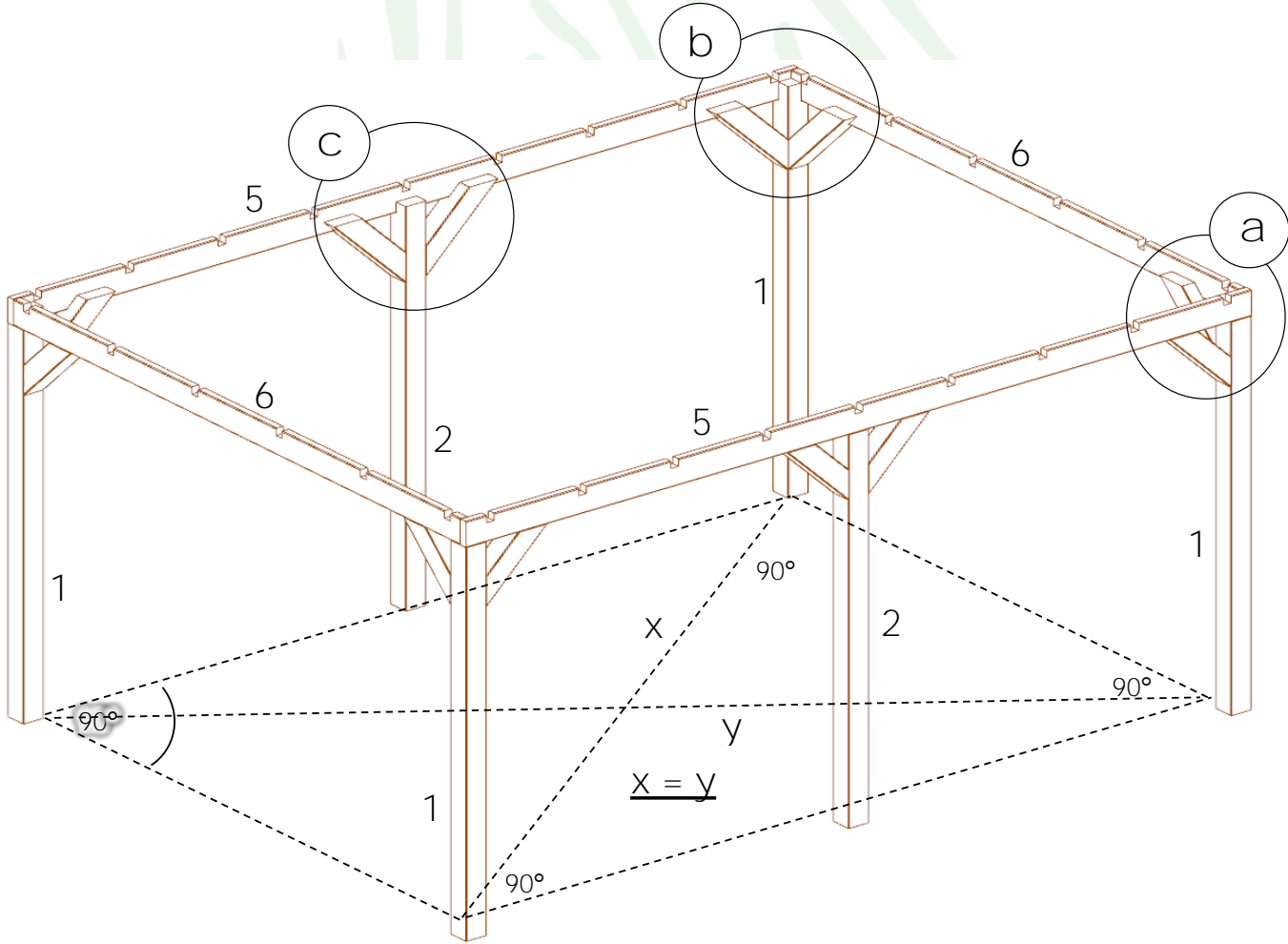
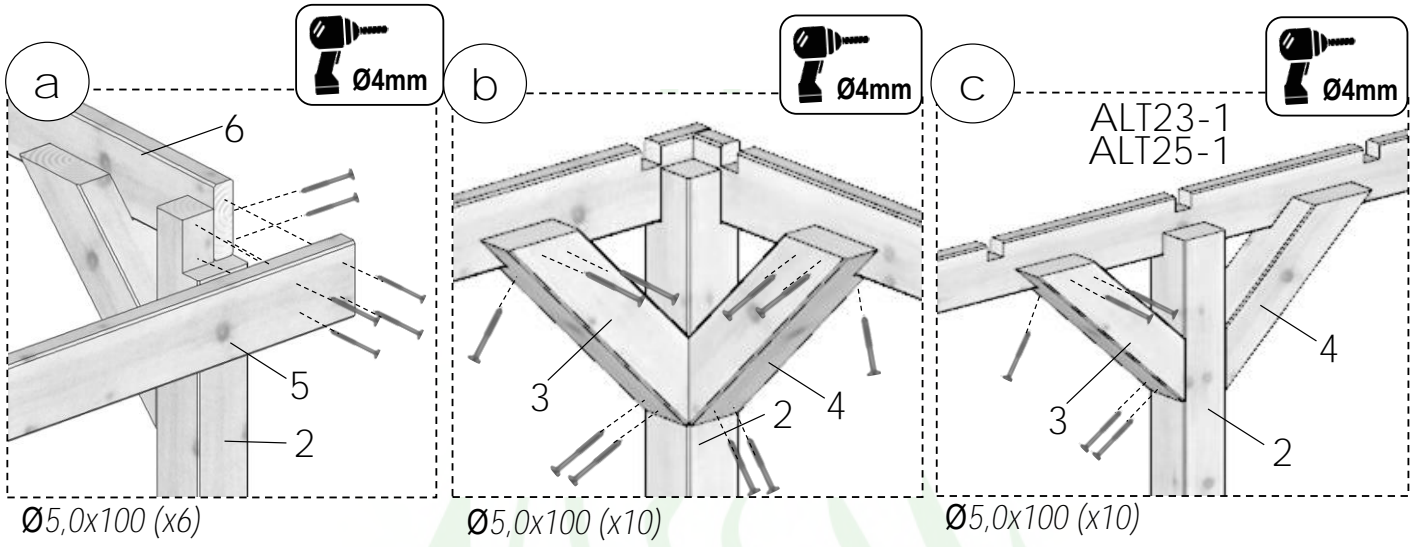

1

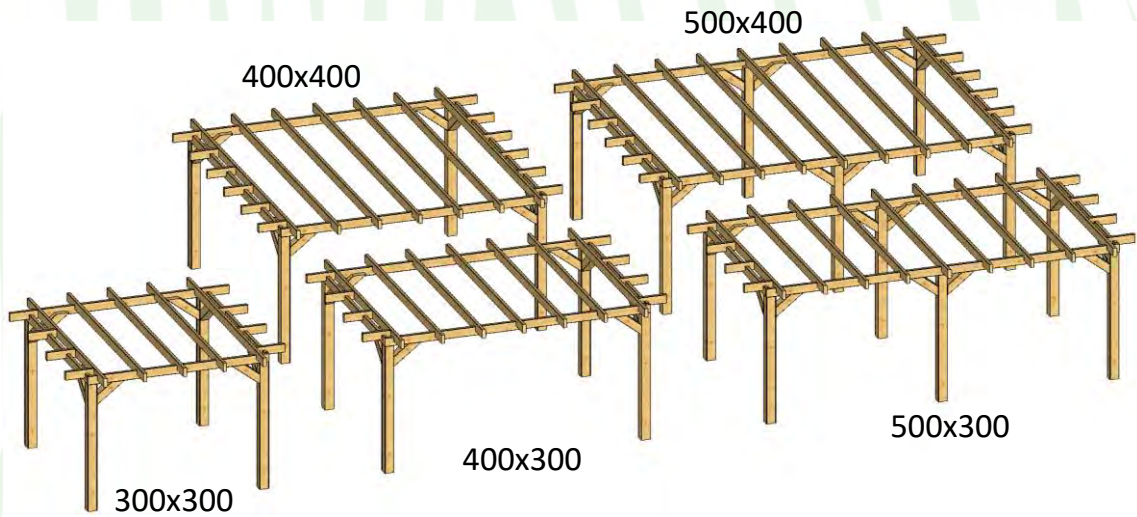
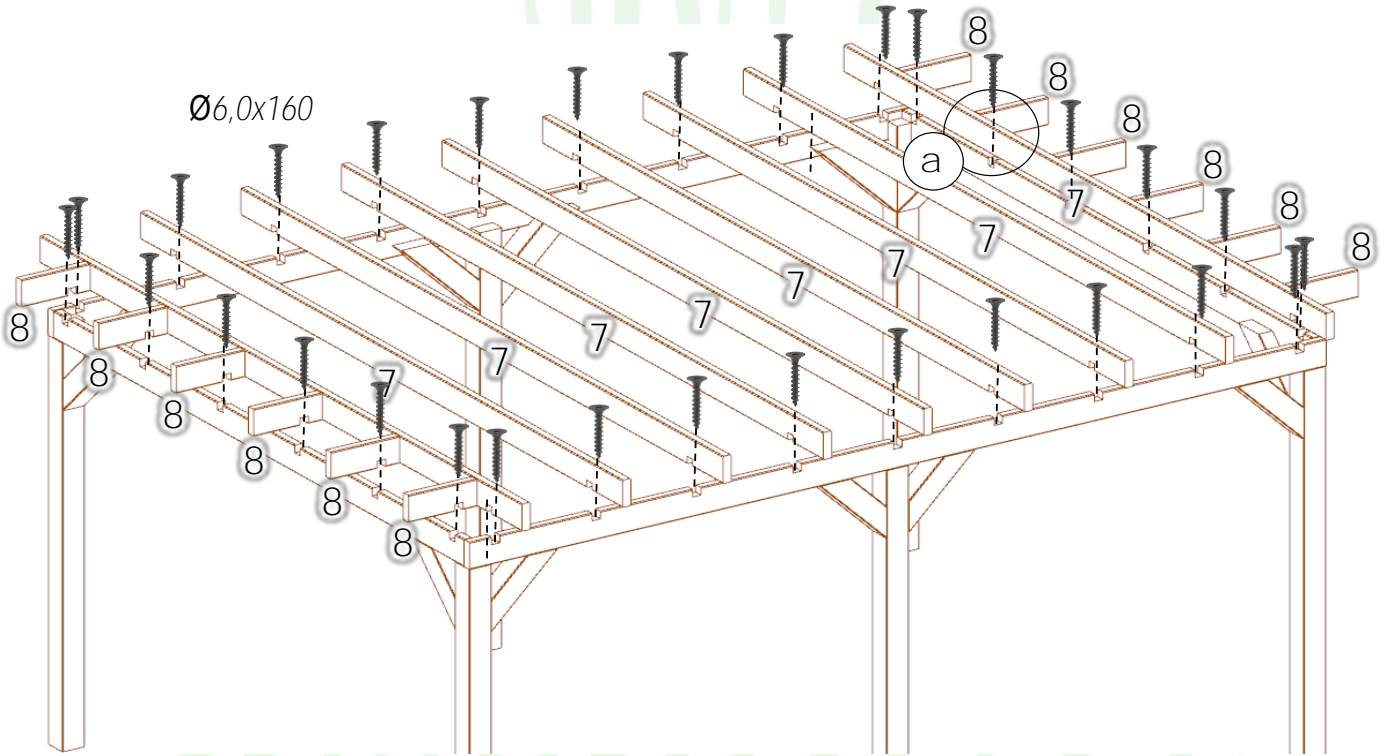
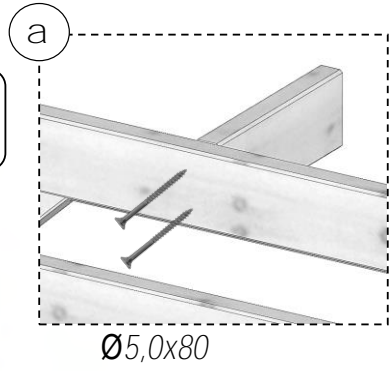

-  Ø5,0x100 x64 (ALT21-1)
(ALT22-1)
(ALT24-1)
-  Ø5,0x100 x84 (ALT23-1)
(ALT25-1)

2



	Ø5,0x80	x16 (ALT21-1) x24 (ALT24-1)		Ø6,0x160	x18 (ALT21-1) x22 (ALT22-1) x26 (ALT23-1) x26 (ALT24-1)
---	---------	--------------------------------	---	----------	--

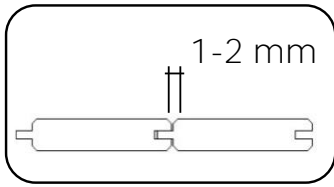

3

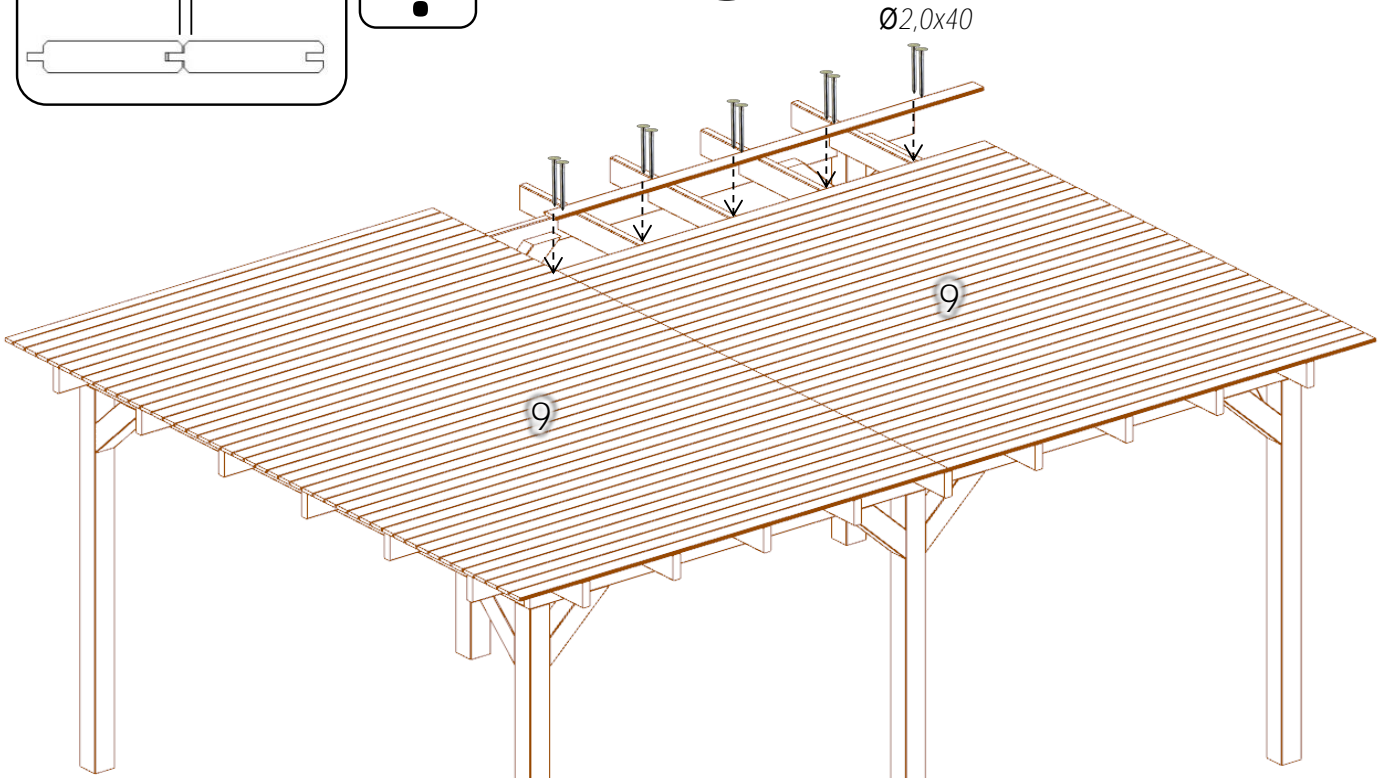



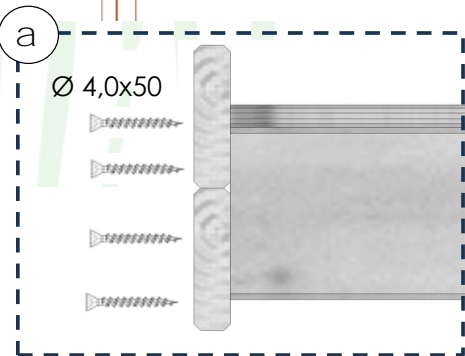
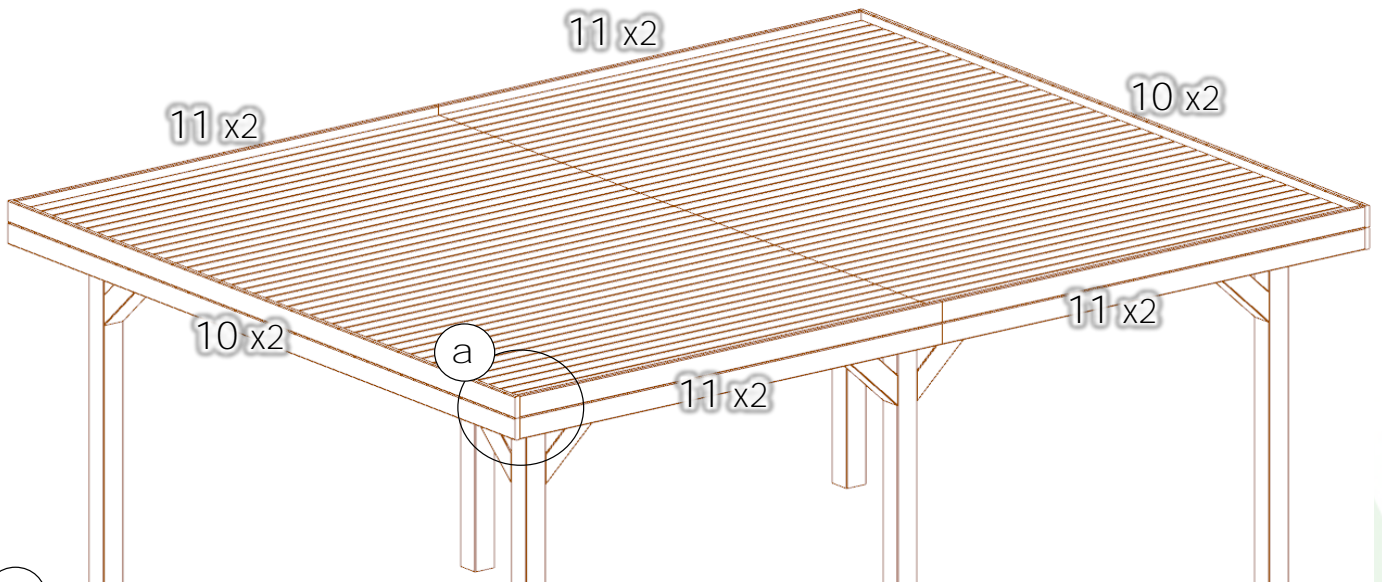



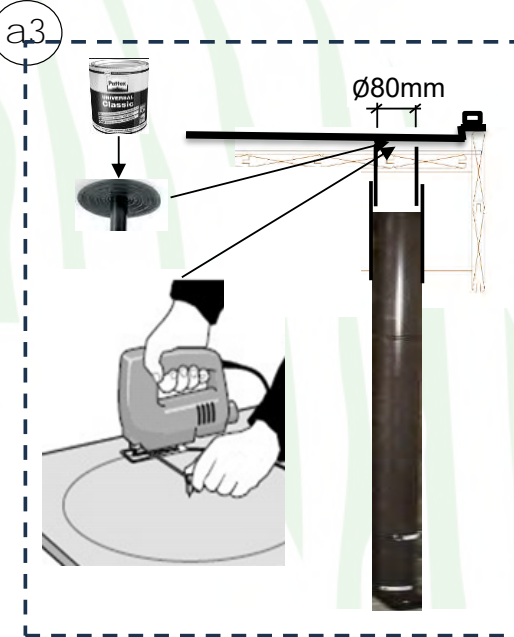
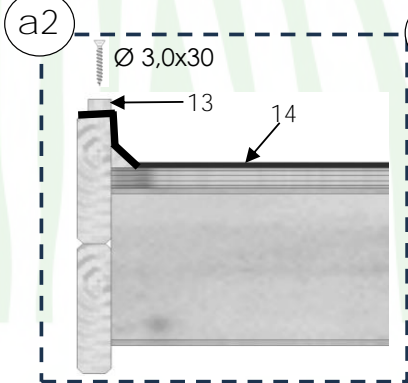
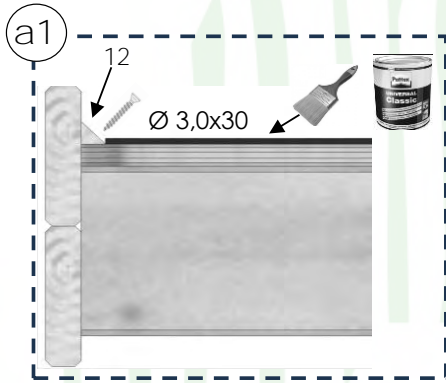
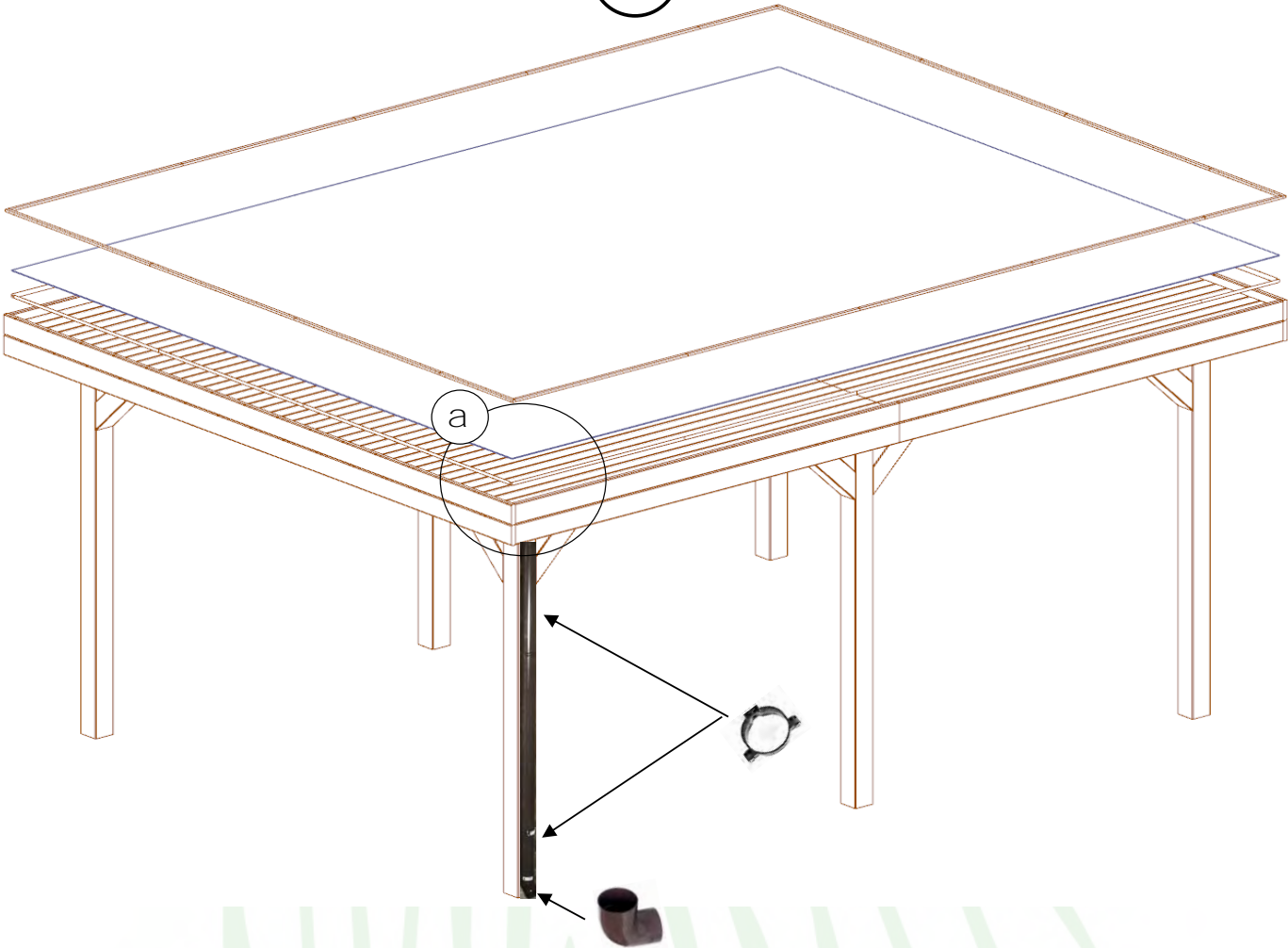

4



<ul style="list-style-type: none"> — x175 (ALT21-1) — x406 (ALT22-1) — x538 (ALT23-1) — x550 (ALT24-1) 	<ul style="list-style-type: none"> — Ø2,0x40 	<ul style="list-style-type: none"> — x72 (ALT21-1) — x84 (ALT22-1) — x96 (ALT23-1) — x96 (ALT24-1) — (ALT25-1)
		<ul style="list-style-type: none"> — Ø4,0x50

5



- | | | |
|---|---------------|---|
|  | x72 (ALT21-1) | x1 (ALT21-1) |
| | x84 (ALT22-1) | x2 (ALT22-1) |
| | x96 (ALT23-1) | x2 (ALT23-1) |
| | x96 (ALT24-1) | x2 (ALT24-1) |
|  | |  |
|  | x1 |  |
|  | x1 |  |



ALT21-1 300x300



ALT22-1 400x300



ALT24-1 400x400



ALT23-1 500x300



ALT23-1 500x400



ALT14-1

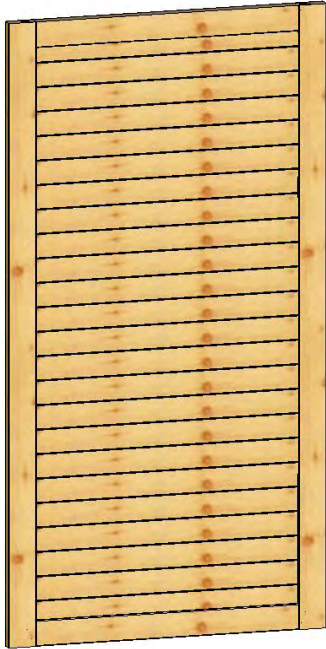

ALT15-1

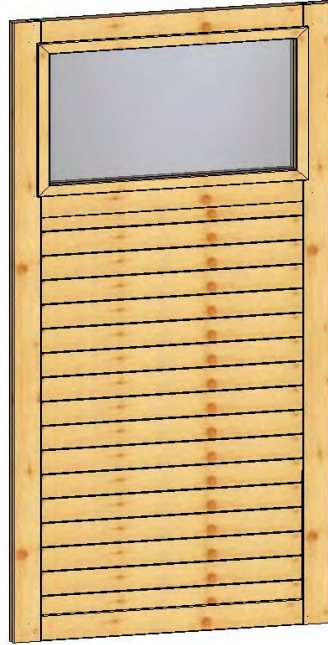

ALT16-1

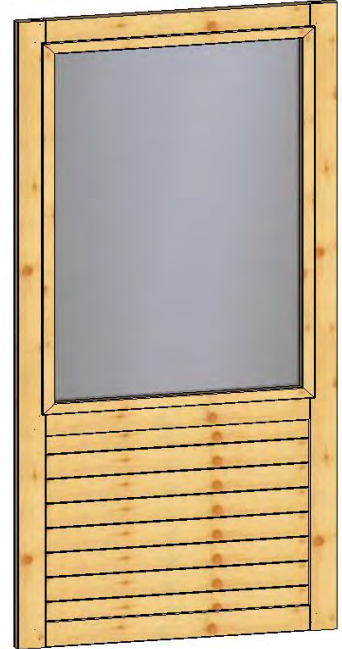

ALT17-1

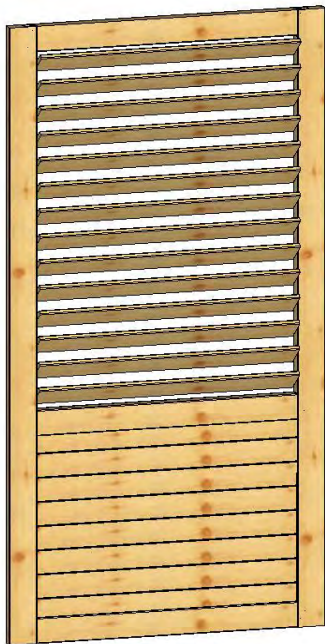

ALT18-1



ALT19-1



ALT20-1



ALT14-1

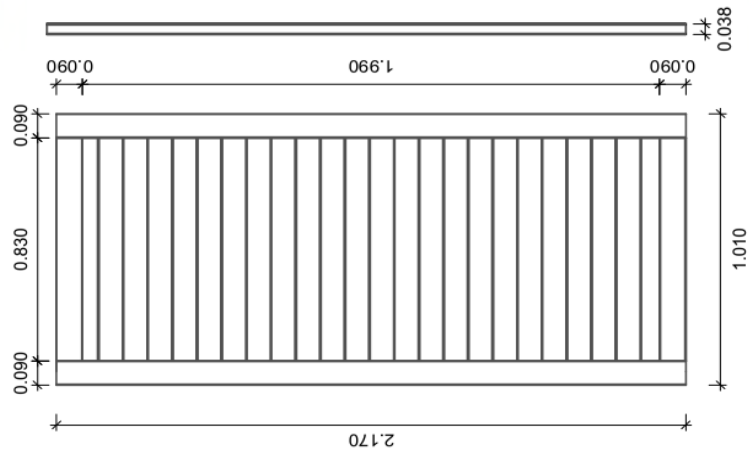

ALT15-1

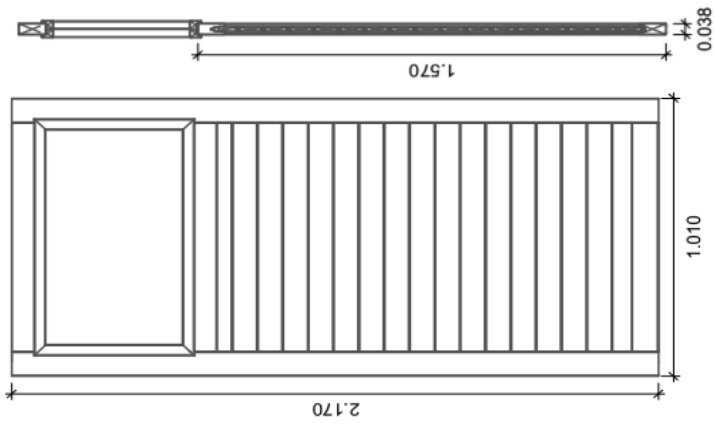

ALT16-1

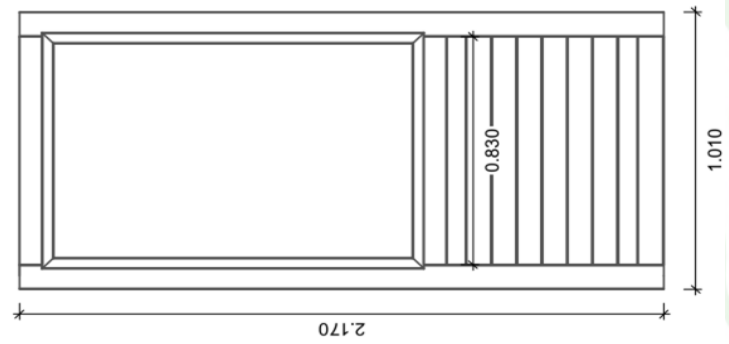

ALT17-1

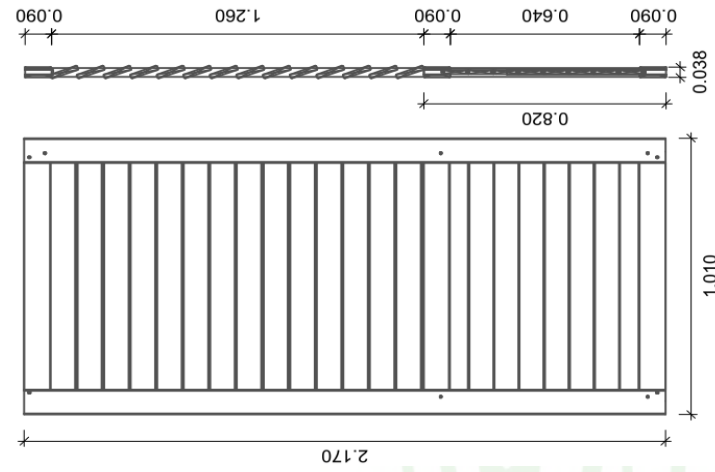

ALT19-1

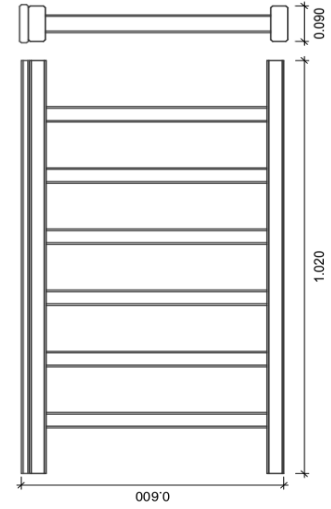



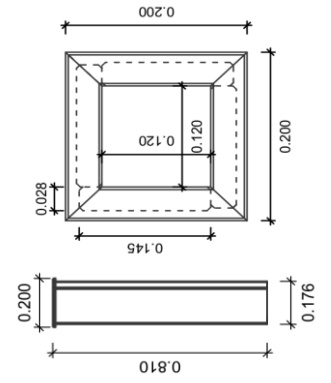

ALT20-1

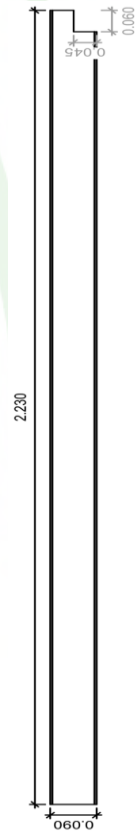





ALT18-1







ALT14-1 101x217





nr	Element	Size (mm)			pcs	miss	dama- ged
		d	h	L			
1		101	38	217	1		
2		25	25	2170	2		
3		25	25	950	1		
nr	Element	Size			pcs	miss	dam.
A		3,5x60			30		



ALT15-1 101x217

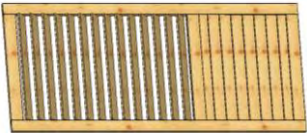

nr	Element	Size (mm)			pcs	miss	dama- ged
		d	h	L			
1		101	38	217	1		
2		25	25	2170	2		
3		25	25	950	1		
nr	Element	Size			pcs	miss	dam.
A		3,5x60			30		





ALT16-1 101x217

nr	Element	Size (mm)			pcs	miss	dama- ged
		d	h	L			
1		101	38	217	1		
2		25	25	2170	2		
3		25	25	950	1		
nr	Element	Size			pcs	miss	dam.
A		3,5x60			30		

ALT17-1 101x217							
nr	Element	Size (mm)			pcs	miss	dama- ged
		d	h	L			
1		101	38	217	1		
2		25	25	2170	2		
3		25	25	950	1		
nr	Element	Size			pcs	miss	dam.
A		3,5x60			30		

ALT18-1 90x223							
nr	Element	Size (mm)			pcs	miss	dama- ged
		d	h	L			
1		90	90	2230	1		
nr	Element	Size			pcs	miss	dam.
A		5,0x80			2		

ALT19-1 60x102							
nr	Element	Size (mm)			pcs	miss	dama- ged
		d	h	L			
1		90	600	1020	1		
nr	Element	Size			pcs	miss	dam.
A		3,5x35			32		
B		60x60x40			4		

ALT20-1 20x83							
nr	Element	Size (mm)			pcs	miss	dama- ged
		d	h	L			
1		28	145	800	4		
2		13	45	210	4		
nr	Element	Size			pcs	miss	dam.
A		3,5x35			12		
B		4,0x70			12		

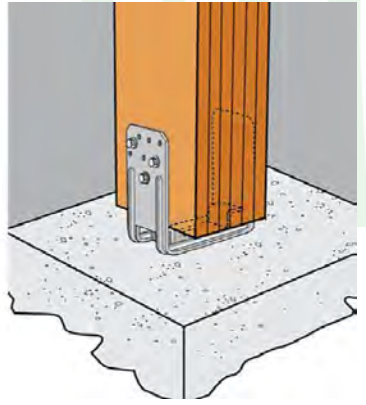
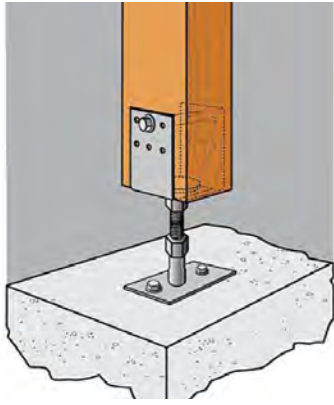
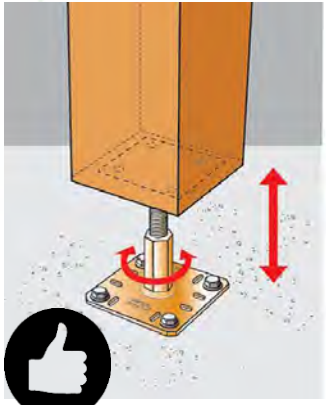
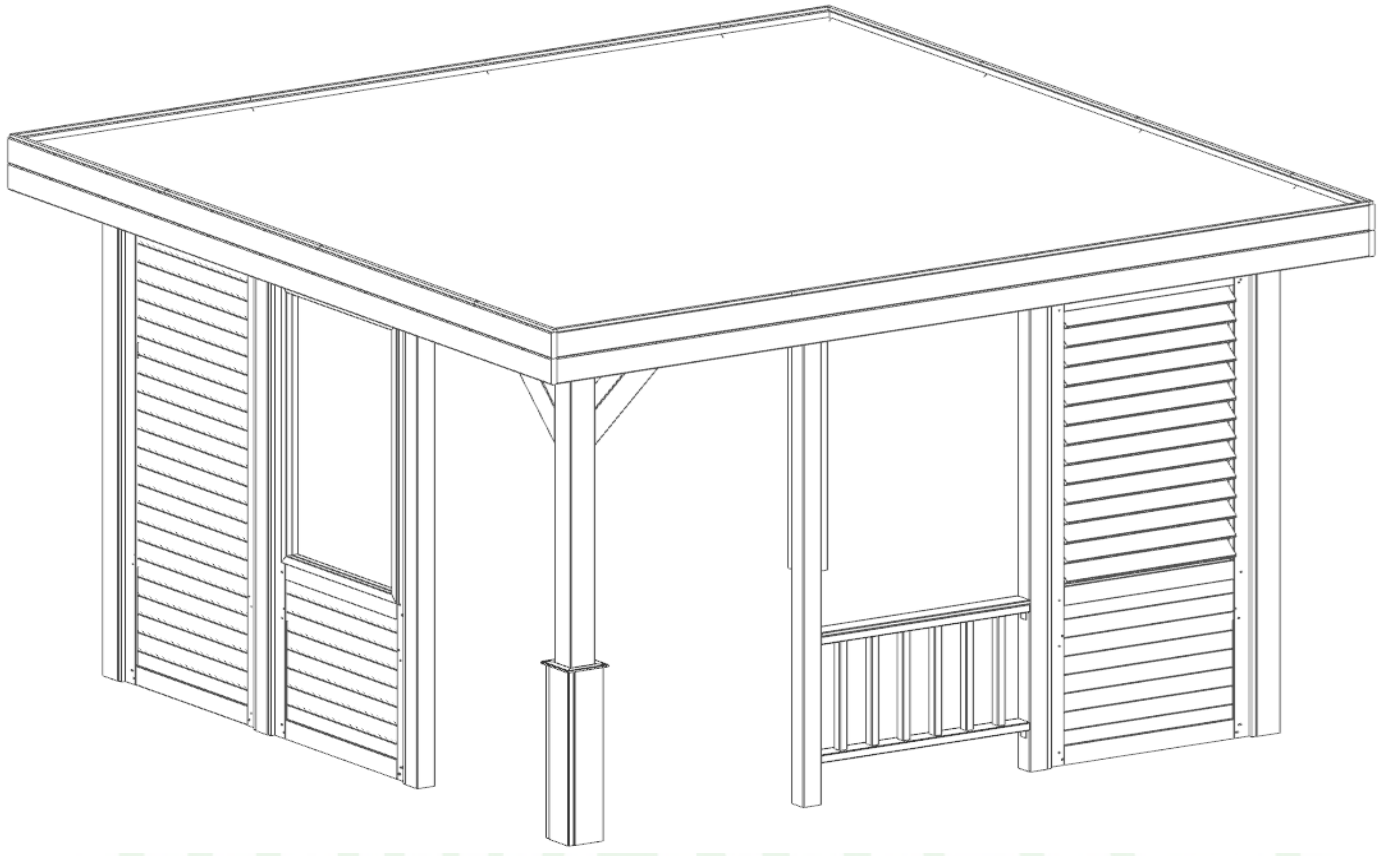
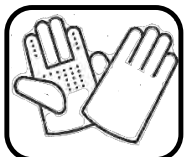
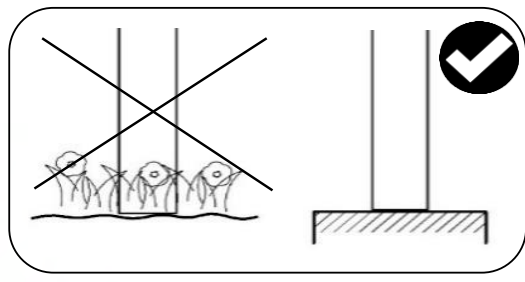
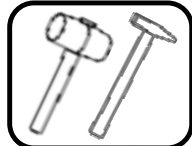
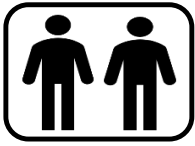

1

ALT14-1, ALT15-1, ALT16-1, ALT17-1

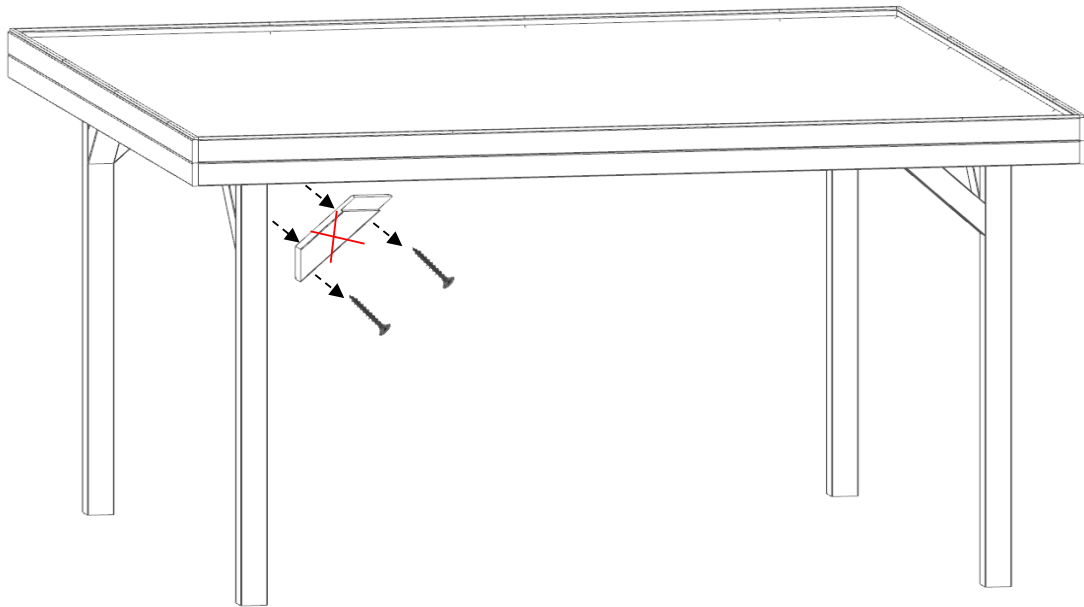

ALT19-1, ALT20-1

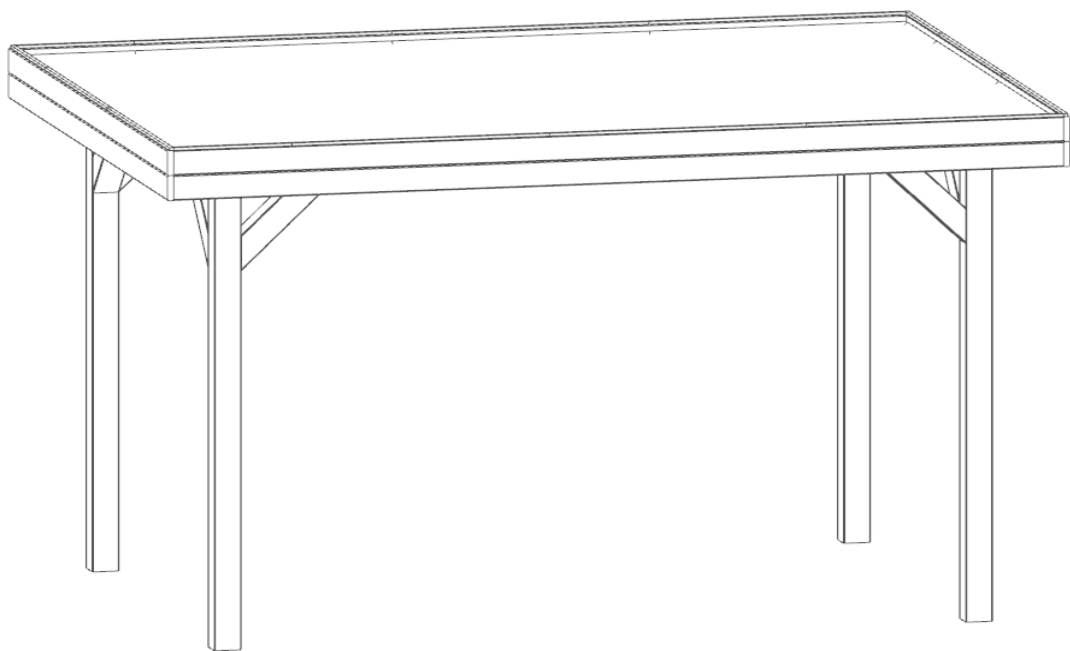

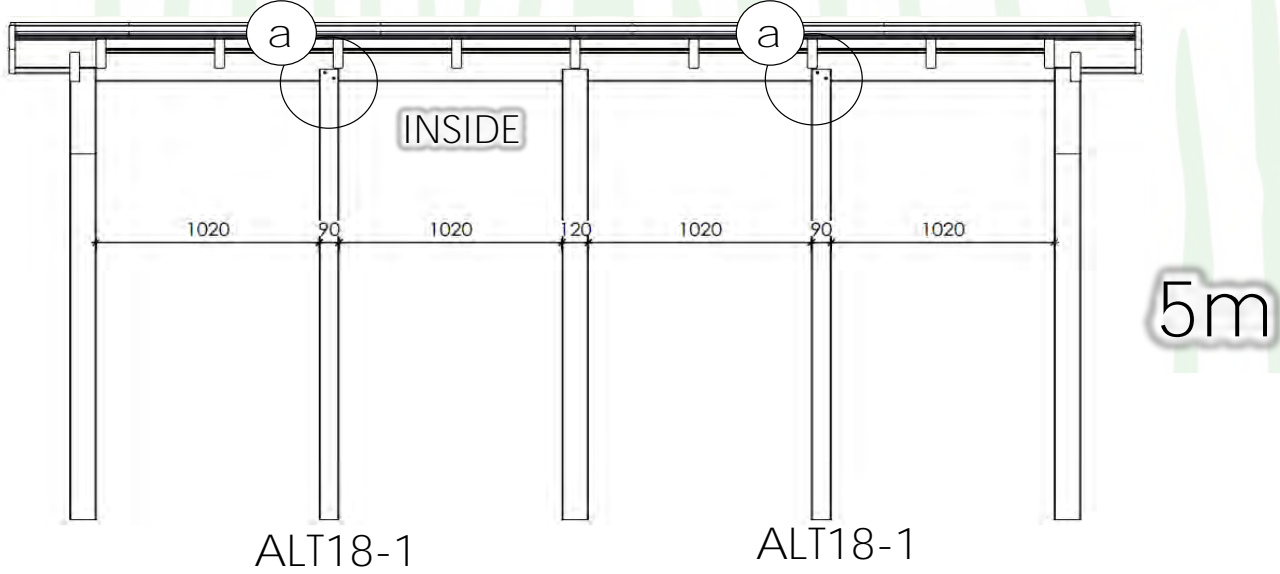
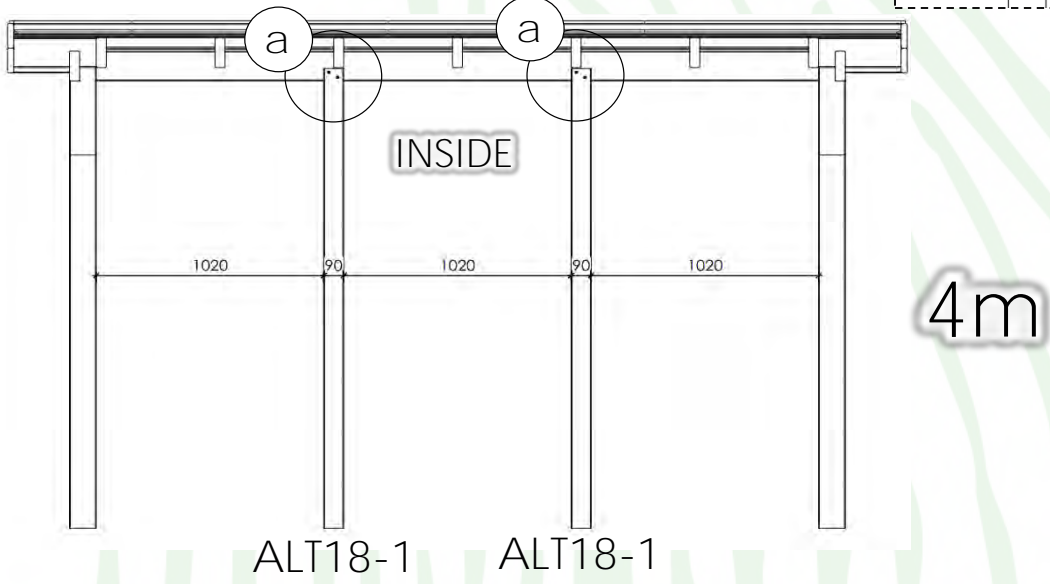
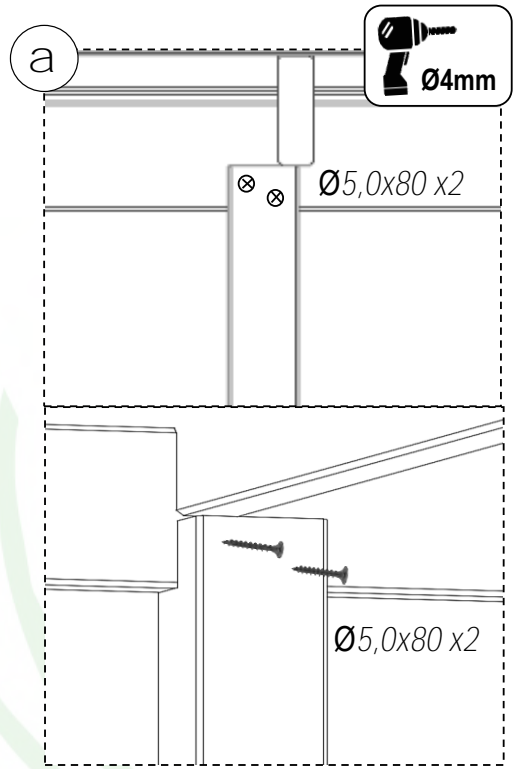
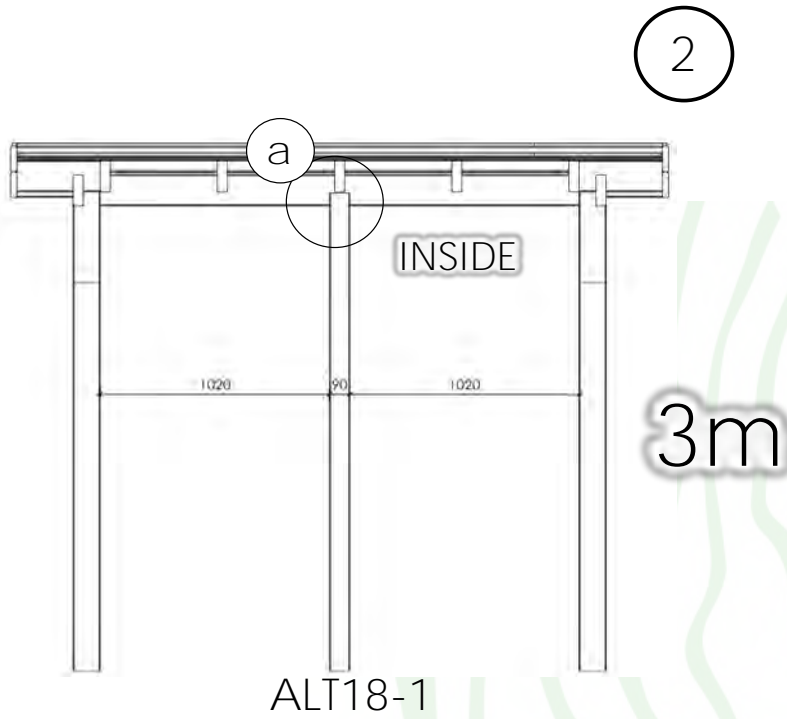

3

ALT14-1, ALT15-1, ALT16-1, ALT17-1

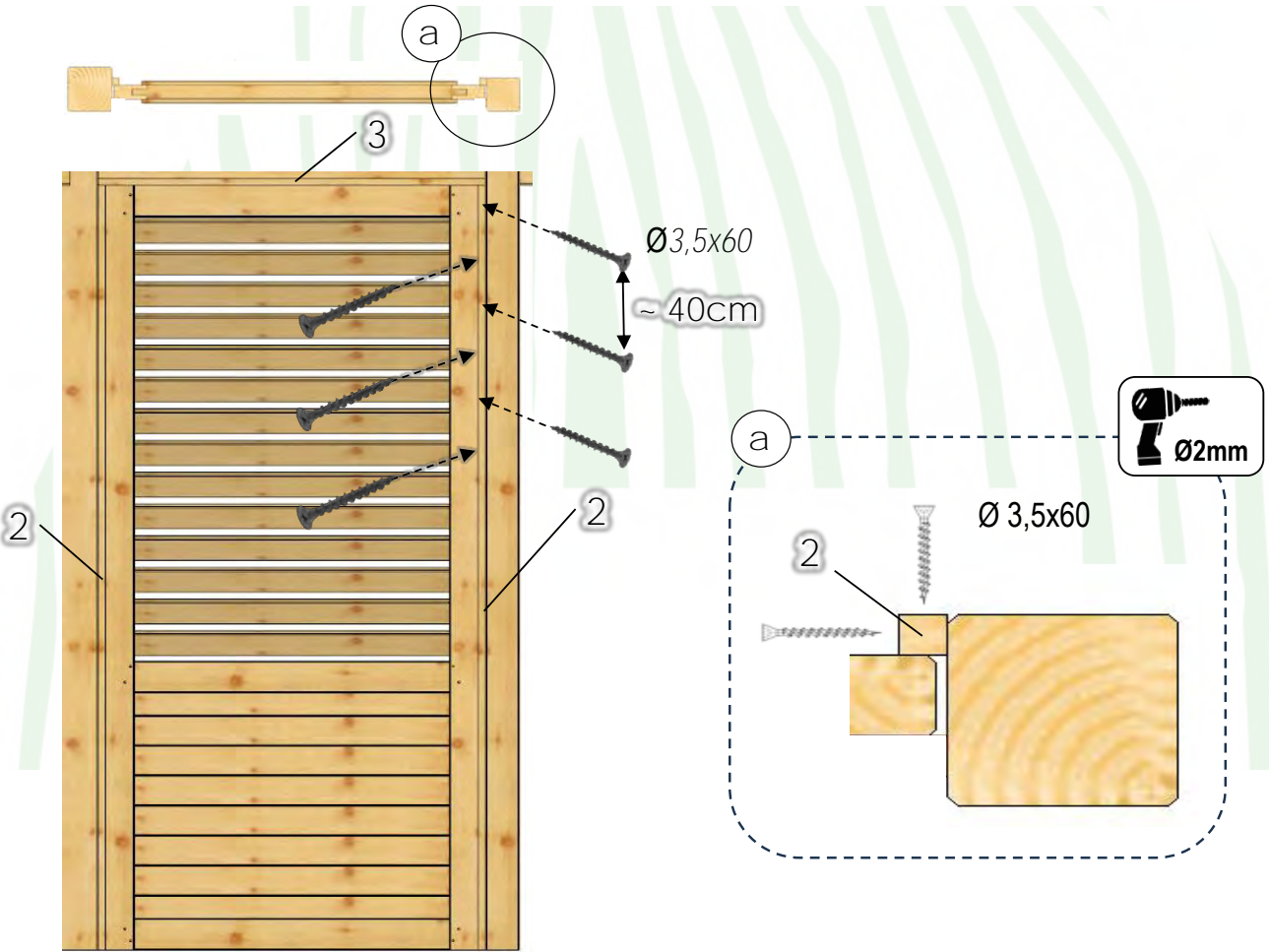
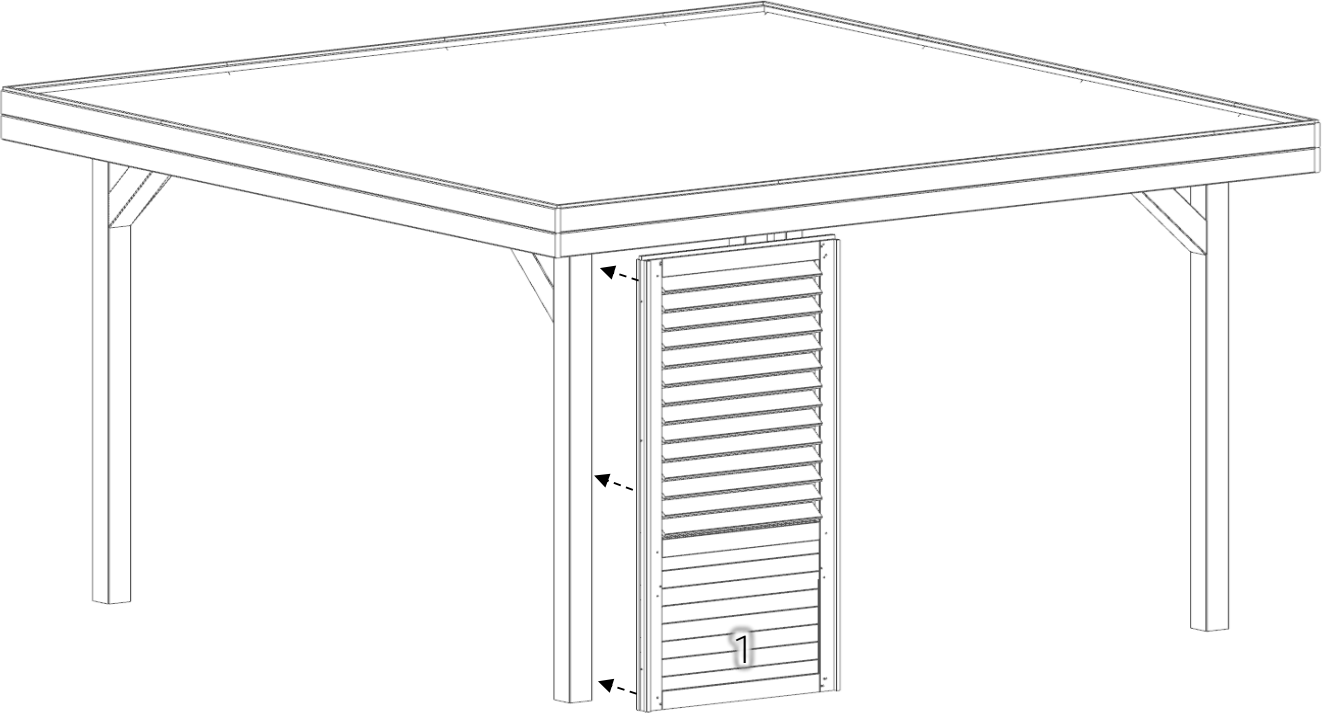

4

ALT19-1

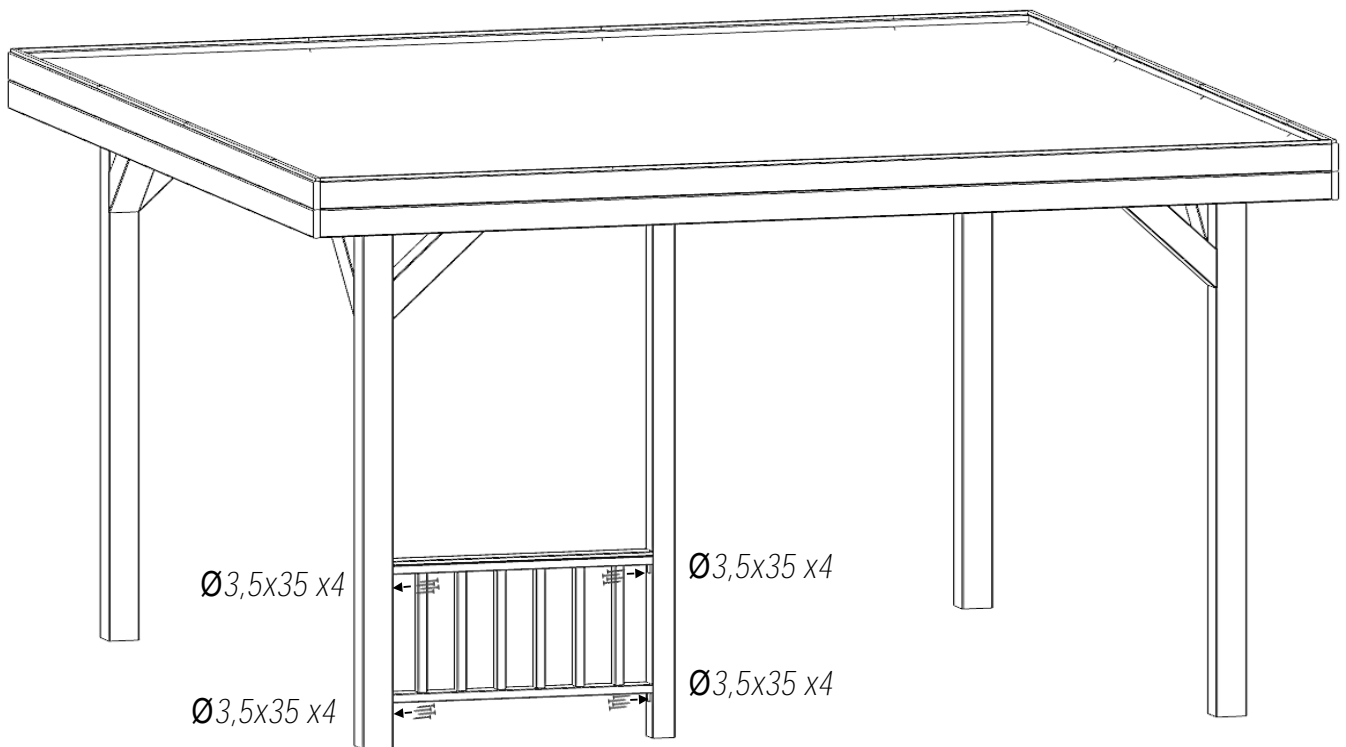
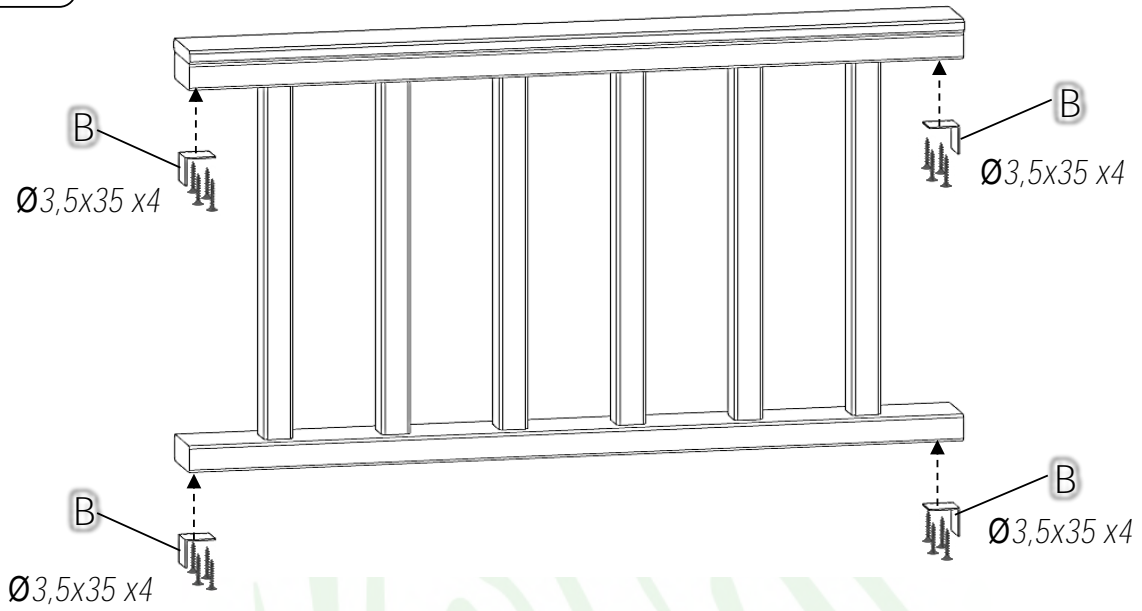
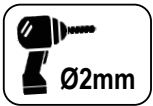

5

ALT20-1

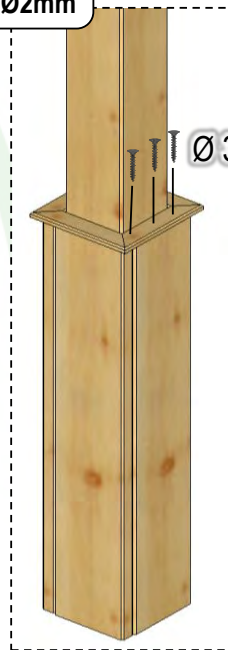
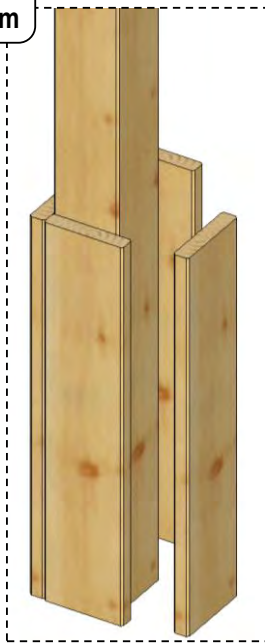
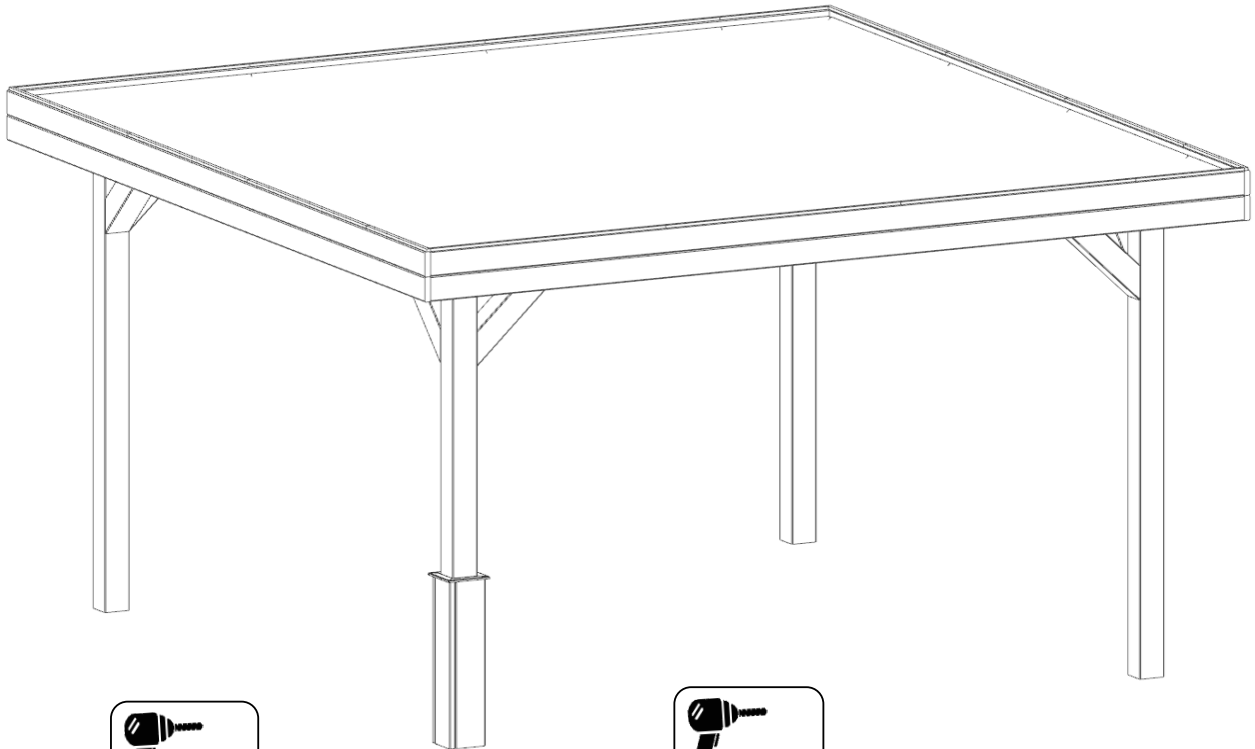

Ø 3,5x35 x3

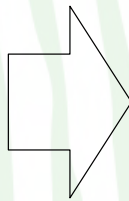

Ø 4,0x70 x3

