

## *Grazie per aver scelto il nostro prodotto.*

Si prega di leggere attentamente il presente manuale prima di iniziare qualsiasi attività.

Il presente manuale deve essere conservato per l'intera vita del prodotto.

Le informazioni contenute in questo manuale sono corrette al momento della scrittura. Le illustrazioni, le foto ed i colori forniti hanno il solo scopo di facilitare il montaggio e non sono in alcun modo vincolanti. L'azienda si riserva il diritto di apportare modifiche parziali o complete in qualsiasi momento senza preavviso ai clienti.

Il prodotto è destinato all'uso privato, escluso l'uso di abitazioni o attività commerciali. È un prodotto tipico da giardino. Le cassette estive possono essere utilizzate per immagazzinare qualsiasi oggetto resistente ai cambiamenti di umidità, mobili da giardino o attrezzi da giardino.

### **STOCCAGGIO DEGLI ELEMENTI:**

1. Si raccomanda di non spacchettare la confezione se il prodotto non verrà montato entro le 72 ore successive.
2. A temperature estremamente elevate superiori a 25°C, si consiglia di installarlo entro 24 ore dall'apertura.



3. Quando la confezione viene spacchettata, gli elementi devono essere conservati su una superficie piana, sotto un tetto al riparo di agenti atmosferici, in un luogo asciutto e arieggiato, in modo che non si deformino e siano protetti dagli agenti atmosferici senza contatto con il suolo (non conservare gli elementi in un locale riscaldato o in un luogo con forte irraggiamento solare).
4. Si consiglia di appesantire gli elementi non imballati per tutta la loro lunghezza.
5. Se il prodotto viene conservato all'aperto, lasciare una pellicola protettiva
6. L'imballaggio del prodotto deve essere smaltito secondo le norme vigenti.
7. L'imballaggio non può essere utilizzato per divertimento. Deve essere tenuto fuori dalla portata dei bambini, poiché esiste il rischio di provocare un incidente (ad es. scivolare sulla pellicola, soffocamento, ingestione di piccole parti, ecc.)
8. Se per qualsiasi motivo l'installazione dovesse essere interrotta nel corso del tempo, proteggere la piscina e le altre parti non installate, da condizioni atmosferiche avverse. In caso contrario, il produttore non sarà responsabile per eventuali danni causati.



## PRIMA DEL MONTAGGIO:

1. Verificare che tutti gli elementi necessari siano inclusi nel pacchetto secondo l'elenco degli elementi in allegato
2. In caso di discrepanze o difetti, si prega di contattare il venditore prima di iniziare il montaggio, ma non oltre 14 giorni dalla data di consegna.
3. Per presentare un reclamo, compilare il modulo di reclamo allegato in modo leggibile inserendo:
  - dati dell'Acquirente
  - descrizione dei difetti + le loro foto
  - numero e quantità di articoli mancanti
  - numero unico del pacco sull'etichetta

### ATTENZIONE:

In caso di assenza delle informazioni di cui sopra, il reclamo non sarà preso in considerazione.

4. Se acquisti direttamente dal negozio Altanka, o tramite una piattaforma di vendita, il i dati di cui sopra devono essere inseriti nel nostro pannello post-vendita, disponibile all'indirizzo del sito web: <https://sav.altanka.com.pl>



## COME TROVARE IL NUMERO DEL PACCO



L'etichetta con il numero del pacco è attaccata anche al pallet.

I documenti si trovano appena sotto l'imballo, sugli elementi in legno.

Kod. i. B. i.	Opis i. specyfikacja	Ilość (szt. / metr. b.)		quant. (b.)	
1		40	77	2600	2
2		48	48	2400	15
3		40	145	2600	2
4		40	125	2600	2
5		40	145	265	28
6		40	145	3800	20
7		40	145	4000	2
8		40	145	2500	1
9		40	145	2000	3
10		45	673	4000	2
11		38	846	1800	1
12		38	846	1800	1
13		38	846	1800	1
14		16	70	1700	1
15		15	59	1600	25
16		15	59	2970	25
17		15	59	3042	2
18		15	59	3008	2
19		15	59	1555	2
20		15	59	1510	2
21		15	59	200	2
22		13	22	1100	23
23		10	70	2000	3
24		3	100	2800	5
25					2



Numero del pacco.



Lo stesso numero di pacco è ripetuto anche sui documenti con l'elenco degli elementi.

5. Scegliere attentamente il luogo in cui deve essere posizionato il prodotto

**NOTA:**

Il prodotto non deve essere installato sotto linee elettriche, sopra le installazioni di terra come elettricità, acqua, gas, dove potrebbe essere necessario l'accesso, e in luoghi in cui tale carico non è previsto. Il prodotto deve essere installato in un luogo in cui non sarà esposto a contatto costante con l'acqua (incluso un sistema di irrigazione).

Il montaggio deve essere eseguita su una superficie uniforme e indurita. Gli elementi in legno non possono avere un contatto diretto con il suolo (usa elementi isolanti, ad es. feltro catramato + travetti - se il tuo modello non li ha nel set, acquistali tu stesso)

6. Verificare con l'ufficio corrispondente al Tuo luogo di residenza, quali regolamenti edilizi si applicano al prodotto da Te acquistato.
7. Eseguire i lavori di fondazione secondo le linee guida contenute in questo manuale. Ricordare che la preparazione delle fondamenta deve essere eseguita in conformità con le pratiche di costruzione (pianificare il tempo necessario per far asciugare il calcestruzzo!)
8. La lastra di cemento deve avere uno spessore minimo di 10 cm e deve essere adattata al terreno.
9. La dimensione della lastra in cemento deve corrispondere alle dimensioni del prodotto (vedere disegno di riferimento).
10. Assicurarsi che le fondamenta siano ben isolate, stabili e livellate
11. Acquistare la quantità necessaria di impregnante (vedi il manuale - per i prodotti non impregnati) e proteggere tutti gli elementi in legno secondo le raccomandazioni del produttore dell'impregnante. Si consiglia di verniciare la casa dopo il montaggio. Se la casa viene dipinta in autunno, nel periodo di calore estremo, ci possono essere luoghi non verniciati che devono essere dipinti. Se gli elementi vengono dipinti prima del montaggio, essi devono essere conservati per l'asciugatura su una superficie piana, protetti da fattori esterni in modo da evitare deformazioni.
12. Si raccomanda l'installazione di grondaie.
13. Nei luoghi in cui è previsto il montaggio con viti, si consiglia di preforare i fori utilizzando un trapano con un diametro inferiore alla dimensione della vite di Ø1.

**IL MONTAGGIO:**

1. Scegliere una giornata calda e soleggiata. I prodotti in legno devono essere installati nell'intervallo di temperatura di 10-25°C. Evitare forti gelate e calore.
2. Durante i lavori, osservare le regole di sicurezza generalmente accettate
3. Installazione di dormienti e pavimenti (pavimento per un costo aggiuntivo):
  - il pavimento può essere in una versione universale in pacchetti di 3 m<sup>2</sup> o essere costituito da soppalchi già pronti
  - durante l'installazione del pavimento, seguire sempre le istruzioni di installazione del pavimento in allegato
  - ricordare di isolarlo correttamente a terra e drenare l'acqua.
4. Montaggio delle pareti:

**ATTENZIONE:** ricordare che elementi correttamente livellati formeranno la base dell'intero prodotto, il loro assemblaggio appropriato influenzerà l'intera durata del prodotto

aggiuntiva allegata. La garanzia del produttore non copre i danni meccanici causati da un montaggio improprio o durante l'uso.



**RICORDA:** il legno è un materiale naturale, quindi possono essere presenti elementi contorti. Durante il loro montaggio, seguire le istruzioni di seguito:

- piano la disposizione degli elementi ritorti in punti diversi per adattarli al meglio alla struttura



- nel caso di tavole attorcigliate cercare di posizionare gli elementi più attorcigliati nella parte inferiore della struttura



Strumenti e materiali che il cliente dovrebbe acquistare:

- A- tavole di sicurezza (incluse)
- B- strisce per incastrare (inclusa)
- C- morsetti per carpenteria
- D- martello di gomma

Operazioni:

1. posizionare le tavole sul lato come mostrato in figura
2. stringere con morsetti
3. incastrare l'elemento attraverso la tavola B con aiuto del martello di gomma D

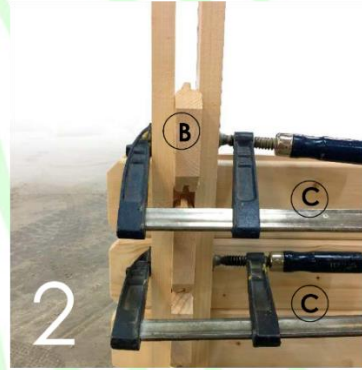

- **IMPORTANTE!!!** assicurarsi che la linguetta sia sempre rivolta verso l'alto!

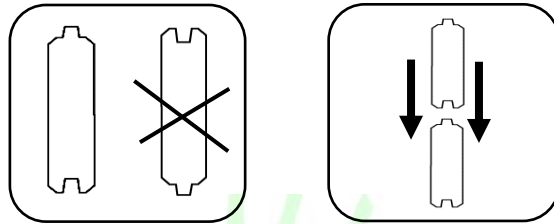

- dopo aver controllato le diagonali del primo strato di tavole (devono sempre avere la stessa lunghezza), è possibile installare ulteriori strati

- ricordare di ancorare correttamente il prodotto a terra (ad es. usando angoli, barre piatte, ecc.)

#### 5. Installazione di porte e finestre:

- prima di installare la falegnameria, controllare la verticale e il livello delle pareti per consentire il loro corretto assemblaggio e ulteriore funzionamento

- seguire sempre le istruzioni del manuale

- prima di assemblare il plexiglass, rimuovere la pellicola protettiva

- i listelli e le inglesine sono pre-tagliati, prima del montaggio ordinare e abbinare le dimensioni dell'apertura nella porta e nella finestra. Se è necessario, tagliare i listelli con attenzione. I chiodi di montaggio devono essere martellati con un martello per tappezzeria piccolo a una distanza di almeno 30 mm dall'estremità.

#### 6. Installazione del tetto a capanna:

**ATTENZIONE! Usa una scala per montare il tetto. Non andare sul tetto!**

**L'accesso al tetto è consentito con riserva durante l'installazione del feltro bitumato/tegola bituminosa e solo quando il tetto è completamente installato, ricordandosi di rispettare il carico massimo del tetto.**

- Si raccomanda di fissare le trave secondo il disegno sottostante

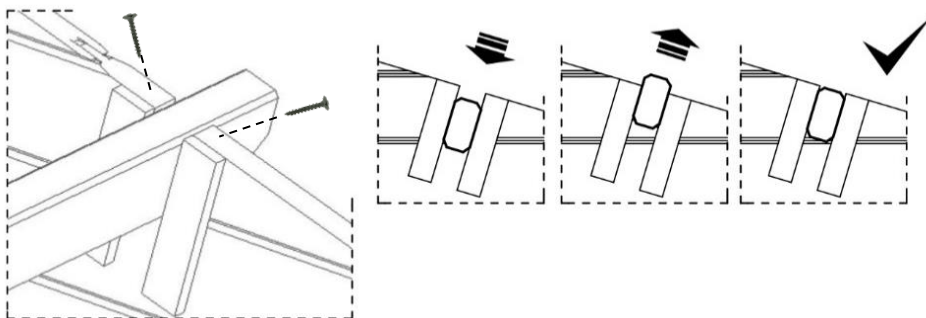

- posizionando le tavole del tetto, ricordarsi di lasciare uno spazio di 1-2 mm tra le tavole, che faciliterà il lavoro del legno e non causerà rigonfiamenti durante l'alta umidità

- modalità del fissaggio delle tavole del tetto



**ATTENZIONE:** il carico massimo sul tetto è di 25 kg / m<sup>2</sup>. Neve, ghiaccio, foglie, ecc. devono essere rimosse sistematicamente.

#### 7. Installazione del tetto a falde:

**ATTENZIONE! Usa una scala per montare il tetto. Non andare sul tetto!**

**L'accesso al tetto è consentito con riserva durante l'installazione del feltro bitumato/tegola bituminosa e solo quando il tetto è completamente installato, ricordandosi di rispettare il carico massimo del tetto.**

- La trave deve essere fissata in cima secondo il disegno sottostante



- posizionando le tavole del tetto, ricordarsi di lasciare uno spazio di 1-2 mm tra le tavole, che faciliterà il lavoro del legno e non causerà rigonfiamenti durante l'alta umidità

- modalità del fissaggio delle tavole del tetto



**ATTENZIONE:** il carico massimo sul tetto è di 25 kg / m<sup>2</sup>. Neve, ghiaccio, foglie, ecc. devono essere rimosse sistematicamente.

## 8. Copertura del tetto:

- il tetto della casa deve essere coperto immediatamente dopo aver finito il montaggio
- i fogli del cartone catramato devono sovrapporsi come indicato nel manuale
- in caso di danneggiamento del cartone catramato, sostituire il pezzo danneggiato con uno nuovo
- è possibile sostituire il cartonfeltro bitumato con tegola bituminosa o altro materiale leggero, tenendo presente il carico massimo di 25 kg / m<sup>2</sup> e garantire la tenuta

## 9. Installazione di doghe anti-tempesta:

- fissando le barre anti-tempesta, praticare un foro di 6 mm nella parte superiore della casa e montarle secondo il disegno. Stringere a mano il bullone di bloccaggio, questo farà sì che il bullone si muova liberamente nell'apertura ovale durante il "lavoro" della parete di legno. Fissare il fondo della stecca con una vite.



### **DURANTE L'UTILIZZO:**

1. Ricordare che la manutenzione regolare del legno e la rimozione sistematica dei rifiuti dall'area del prodotto sono indispensabili. Si prega di notare che un prodotto acquistato in versione non impregnata deve essere immediatamente protetto. Si consiglia di rinfrescare l'impregnante una volta all'anno. **ATTENZIONE!** Per mantenere la garanzia, conservare le ricevute di vendita dell'impregnazione.
2. Utilizzare prodotti di alta qualità per proteggere il legno.
3. Almeno una volta l'anno controllare le condizioni tecniche del prodotto:
  - prestare attenzione alla tenuta del rivestimento del tetto, se necessario sostituire il cartone catramato del tetto con uno nuovo
  - controllare che il prodotto sia sufficientemente ventilato (se necessario, installare le griglie di ventilazione per evitare il formarsi dell'umidità)
  - verificare il funzionamento delle parti mobili (porte, finestre)
  - lubrificare la serratura e le cerniere

4. In inverno, rimuovere sistematicamente la neve dal tetto. Non permettere che il carico sul tetto superi i 25 kg / m<sup>2</sup>.
5. Prendere sempre cura della pulizia all'interno e all'esterno del prodotto acquistato. Ricordare che foglie, rami, erba o acqua stagnante possono contribuire a un rapido degradamento del legno.
6. Non agganciare o torcere insieme le tavole delle parete poiché ciò impedirebbe al legno di lavorare. Un'eccezione può essere rappresentata dai modelli di case con una costruzione speciale, dove è indicato nelle istruzioni di montaggio.
7. Non appendere gli armadi alle pareti, non avvitare gli scaffali.
8. Lasciare spazio sotto il tetto per la ventilazione e i lavori di falegnameria.

### **GARANZIA:**

Il legno è un materiale vivo, quindi la cosa naturale è che lavora con i cambiamenti di temperatura e umidità. Sebbene attribuiamo grande importanza alla qualità del legno utilizzato nei nostri prodotti, non possiamo evitare alcuni dei fenomeni naturali presentati di seguito, che non sono coperti dalla garanzia:

<b>caratteristica naturale del legno</b>	<b>Immagine</b>	<b>Indicazioni</b>
cambiamenti di colore nel tempo, scolorimento o differenze di colore e struttura		Utilizzare i preparati disponibili per l'impregnamento del legno secondo le istruzioni del produttore.
tutti i nodi fino a 2 cm di diametro, così come i nodi naturali, sani (con colore scuro o pallido) sopra i 2 cm		È possibile usare un mastice per legno o silicone.
fessure		È possibile usare un mastice per legno o silicone. Le fessure hanno una natura stagionale, lavorano con i cambiamenti di umidità.

necrosi laterale		È possibile usare un mastice per legno o silicone
bolle di resina fuoriuscite di resina		Le fuoriuscite secche possono essere eliminate con uno strumento appuntito, facendo attenzione a non danneggiare la struttura del legno.
fioriture resinose		Per la rimozione è possibile utilizzare un solvente a base di acetone, trementina o benzina. Dopo la lisciviazione, lavare più volte con acqua tiepida e una piccola quantità di acido acetico.
macchia blu		Utilizzare preparati disponibili in commercio per rimuovere la macchia blu secondo le istruzioni del produttore.
muffa superficiale		Utilizzare preparazioni disponibili in commercio per rimuovere la muffa superficiale di legno in base alle istruzioni del produttore.

### **La garanzia copre (valida solo con la prova di acquisto):**

1. Protezione del legno di 2 anni contro insetti (escluse termiti, formiche e api australiane) e funghi se sono soddisfatte le seguenti condizioni:
    - il prodotto acquistato in versione non impregnata è stato impregnato con agenti generalmente disponibili come impregnanti, protezioni antimacchia, ecc. entro e non oltre la data dell'assemblea
    - il legno non ha contatto diretto con terra e acqua (incluso anche un sistema di irrigazione)
    - il legno viene trattato ogni anno con agenti impregnanti, protezioni antimacchia, ecc. disponibili in commercio.
- NOTA: senza il trattamento annuale della struttura in legno, la garanzia scade. Ricordati di conservare la prova d'acquisto.**
2. difetti di fabbrica ed elementi mancanti nel caso di ferramenta - 1 anno (garanzia valida solo prima del montaggio) - la garanzia è limitata alla sostituzione degli articoli difettosi, esclusa la riparazione di qualsiasi altro danno causato dallo stesso elemento difettoso.
  3. difetti di fabbrica e elementi strutturali mancanti (garanzia valida solo prima del montaggio) - la garanzia è limitata alla sostituzione degli articoli difettosi, esclusa la riparazione di qualsiasi altro danno causato dall'elemento difettoso.
  4. garanzia valida solo nel paese in cui è stato effettuato l'acquisto
  5. la garanzia non è valida in caso di modifiche indipendenti al prodotto.
  6. gli interventi sotto garanzia non prolungano la durata della garanzia stessa.

### **La garanzia non copre:**

- le caratteristiche naturali del legno sopra indicate
- deformazioni naturali, ad esempio causate da un'esposizione prolungata al sole
- distorsioni e deformazioni durante il montaggio
- danni e difetti causati da errato trasporto, conservazione, installazione, uso e/o mancata manutenzione
- corrosione di elementi metallici
- elementi incollati
- danni derivanti dalla scarsa preparazione dell'area
- danni derivanti dall'intervento di persone non autorizzate
- danni causati dall'uso per scopi pubblici o commerciali
- danni causati da forze esterne come terremoti, incendi, frane, alluvioni, vento, tempesta, grandine e altre precipitazioni e fenomeni atmosferici
- danni causati da termiti, formiche o api australiane
- difetti visibili che l'acquirente dovrebbe notare al momento della consegna
- costi del lavoro, costi di trasporto, ecc. (rimangono a carico dell'acquirente)
- danni causati da allagamenti, infiltrazioni (anche dovuti ad errata installazione del tetto)

## CARATTERISTICHE TECNICHE DEL LEGNO

Nota:

Il legno è un materiale vivo, quindi è naturale che funzioni con l'umidità e la temperatura. Sebbene diamo grande importanza alla qualità del legno utilizzato nei nostri prodotti, non possiamo evitare alcuni fenomeni che costituiscono le caratteristiche naturali del legno: cambiamenti di colore, nodi naturali, crepe, corteccia tra la corteccia, resina, colate di resina, sale, brunitura, muffe superficiali o curvature che non impediscono l'assemblaggio.

Tenendo conto della lavorazione permanente del legno, le dimensioni comunicate sono solo indicative (possono variare da  $\pm 2$  al 12% a seconda della sezione trasversale e della direzione misurata).

Va inoltre ricordato che il legno non è un materiale ermetico, impermeabile, ed è anche caratterizzato da un'elevata igroscopicità, pertanto, in caso di forti precipitazioni o di elevata umidità dell'aria, esiste il rischio di penetrazione dell'acqua.

Per ridurre al minimo l'assorbimento del legno possono essere utilizzati preparati speciali, ad esempio oli per impregnazione con cera.

Negli edifici residenziali o nelle case da giardino, dove ci preoccupiamo della tenuta, puoi inoltre riempire gli spazi vuoti con geotessile, lana minerale o inserti in gomma e lana, anche riempimenti sintetici, ad esempio silicone o massa per sigillare materiali in legno, adatti anche per fissare i collegamenti, ad esempio negli angoli della casa.

**ATTENZIONE: i lavori aggiuntivi, come la sigillatura, vengono eseguiti da soli e a proprio rischio. Seguire sempre le raccomandazioni del produttore. Si ricorda che la sigillatura del prodotto prevede anche l'utilizzo di un'adeguata ventilazione.**

Alcuni degli elementi che utilizziamo sono finger-joint. Tale legno è più resistente del legno massiccio e meno suscettibile a torsioni e deformazioni.

# DOM118-2

## 300x300cm

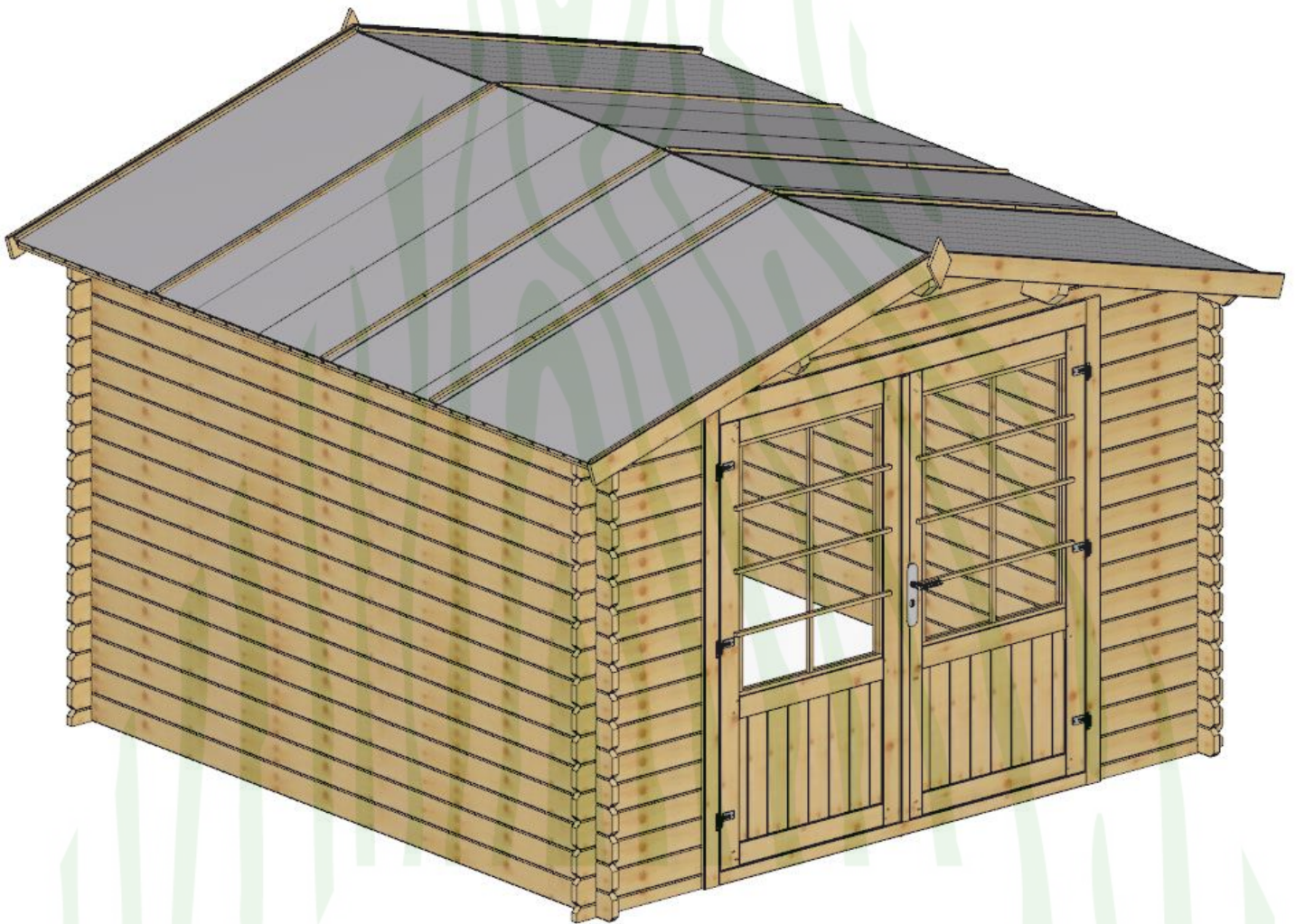
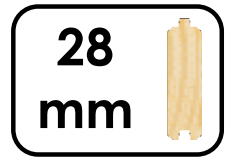





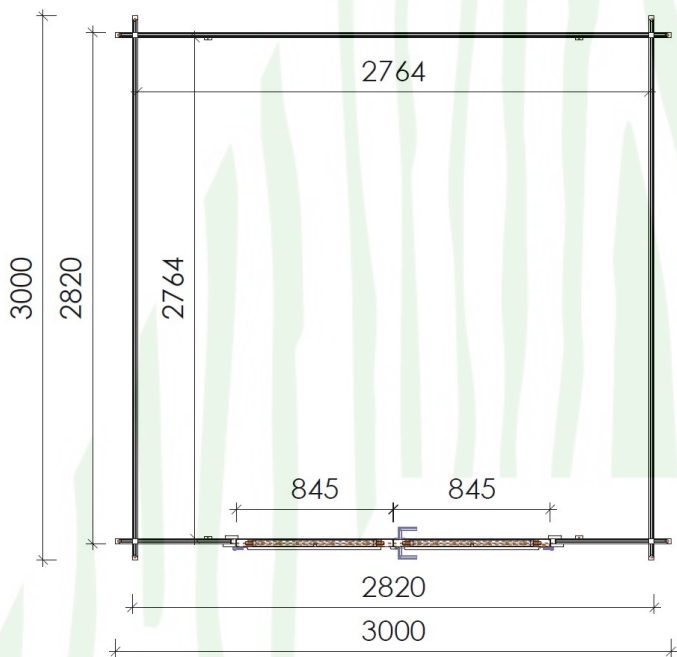
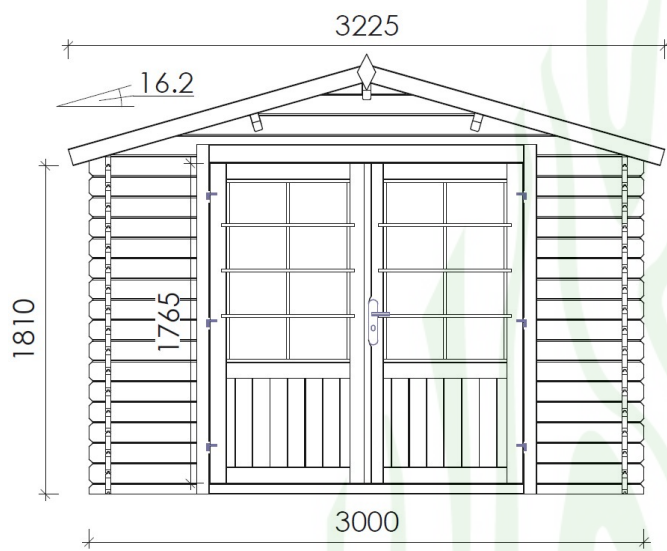































# DOM118-2 300x300 28mm



DOM118-2 300x300 28mm

nr	Element	Size (mm)			pcs	miss	dama- ged
		d	h	L			
1		28	121	3000	48		
2		28	113	3200	2		
3		28	65	3000	1		
4		28	65	3000	1		
5		28	121	622	32		
6		13	45	2000	4		
7	SZC21-1 	28	453	3000	2		
8		45	145	3200	3		
9	OSCP01 	61	82	1926	1		
10	OSCL01 	61	82	1926	1		
11	NAD01 	61	112	1746	1		
12	PRO01 	16	55	1700	1		
13	DRZ03-4 	38	845	1765	1		
14		16	99	1640	72		
15		13	22	1150	26		
16		16	95	1680	4		
17		16	110	165	2		
18		3	1000	3750	4		
19		16	16	1000	30		
20	plexiglass 	1,5	660	1000	2		
21		19	19	1900	4		

nr	Element	Size	pcs	miss	dam.
A		3,5x25	<b>129</b>		
B		3,5x35	<b>58</b>		
C		3,5x40	<b>28</b>		
D		5,0x100	<b>6</b>		
E		1,6x30	<b>102</b>		
F		2,0x40	<b>464</b>		
G		6,0x50	<b>4</b>		
H		M6	<b>4</b>		
I		Ø6	<b>4</b>		
J		15x15x15	<b>16</b>		
K			<b>1</b>		
L			<b>1</b>		
M			<b>6</b>		
N		L-50	<b>2</b>		

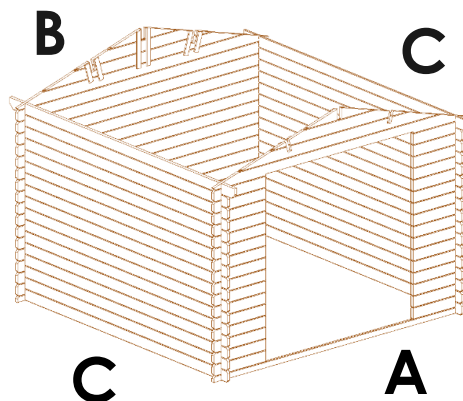
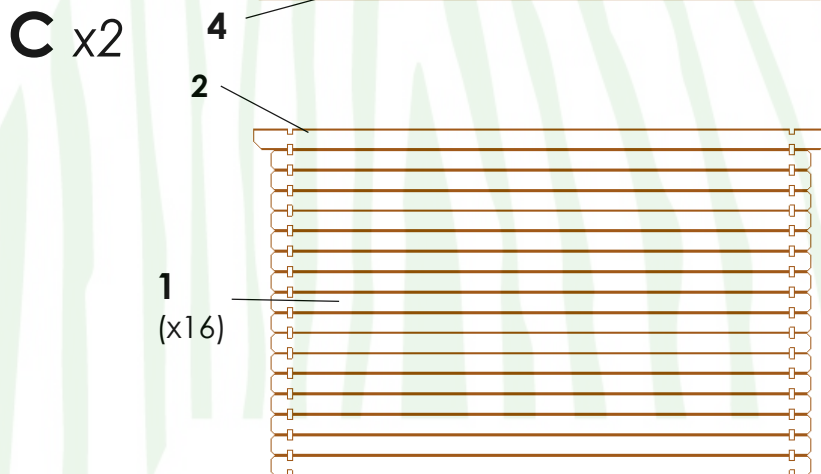
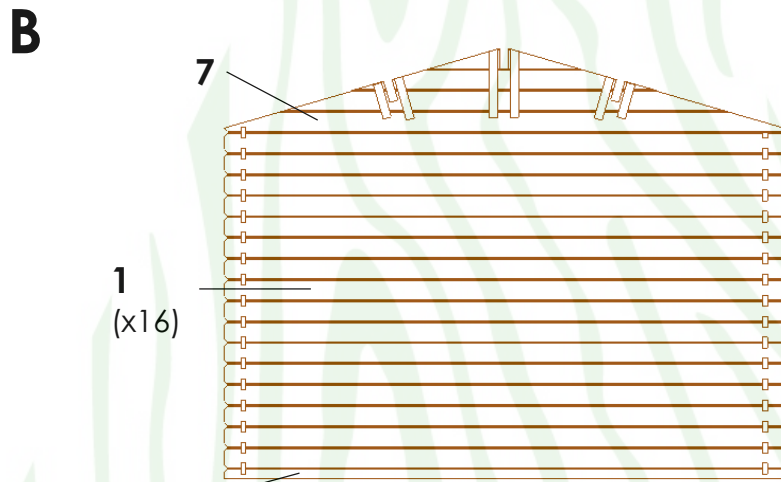
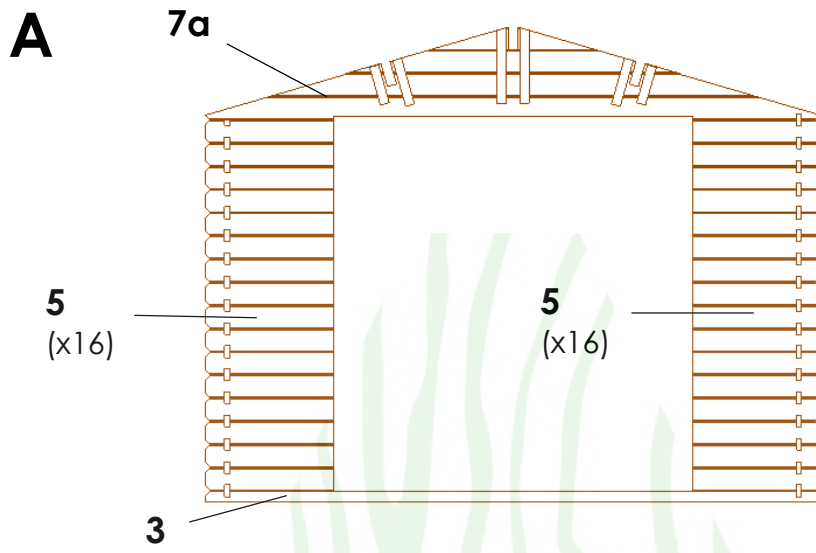

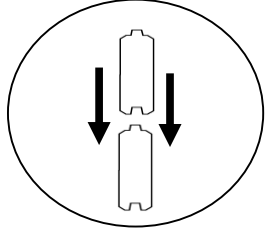
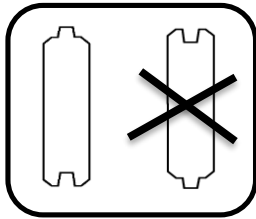
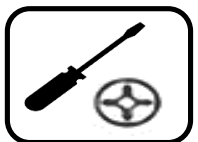
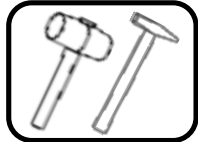
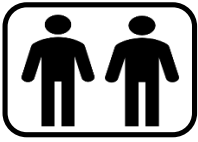

min. 100mm

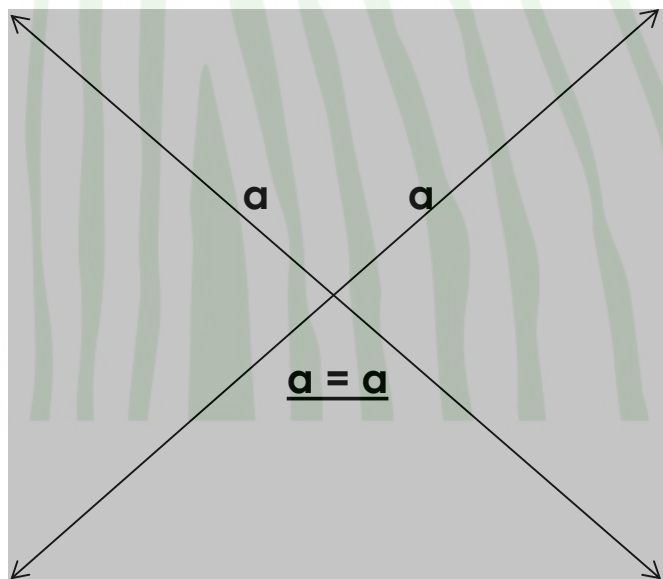

2820 mm

2820 mm

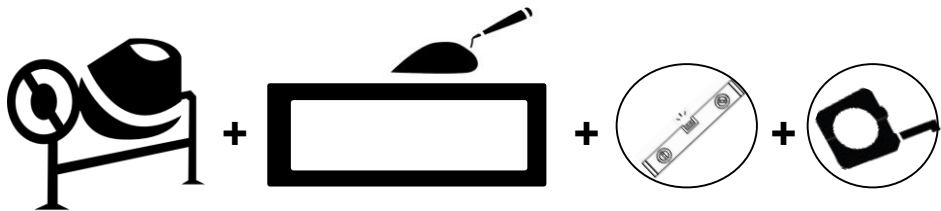

1

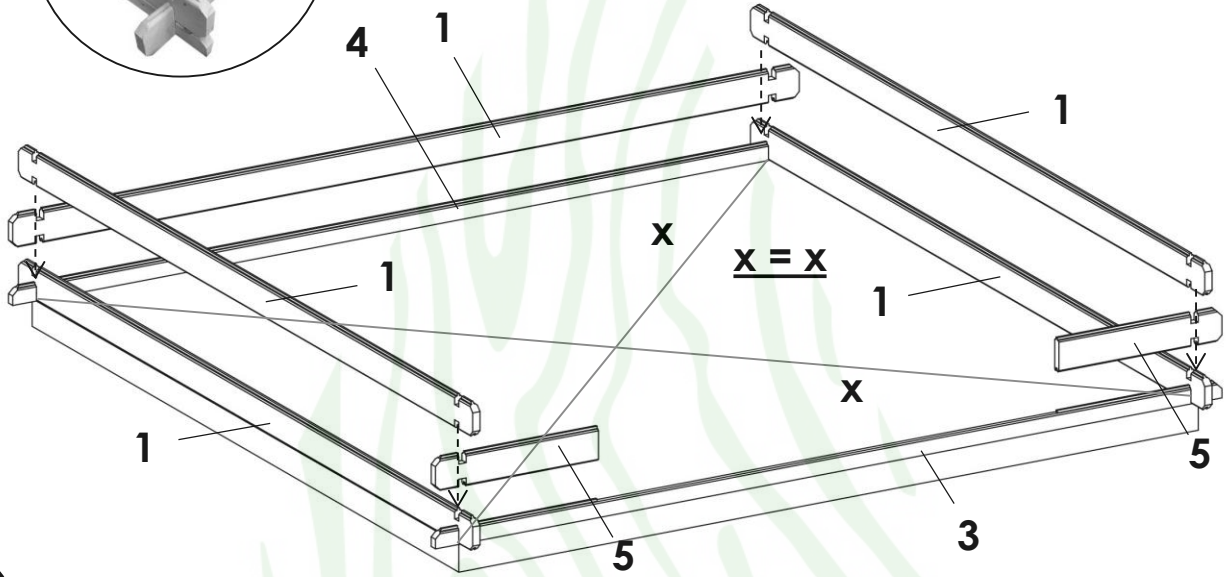
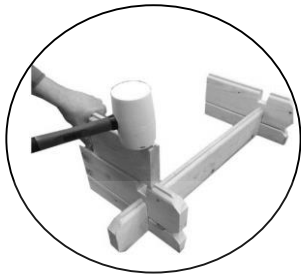

2

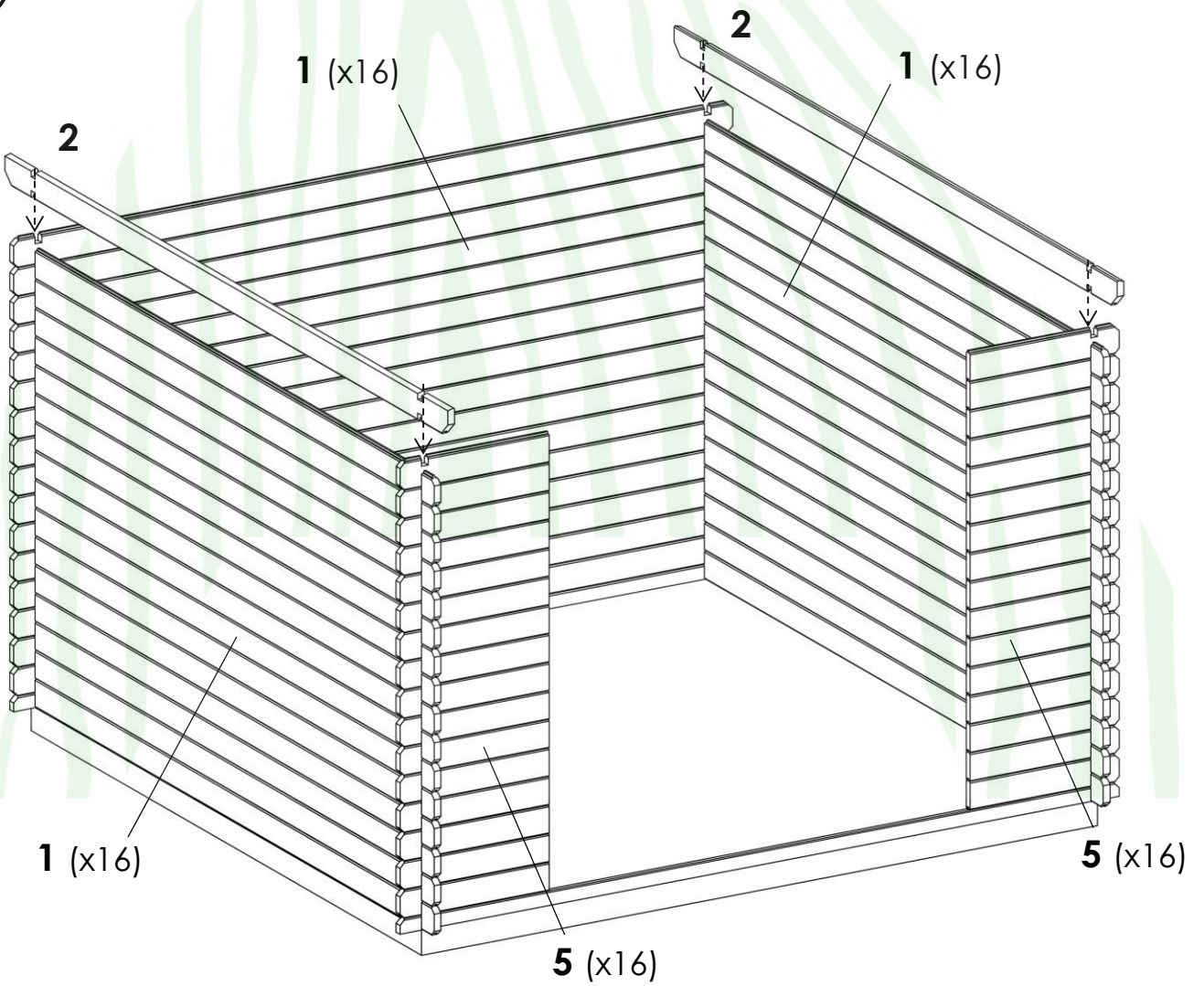



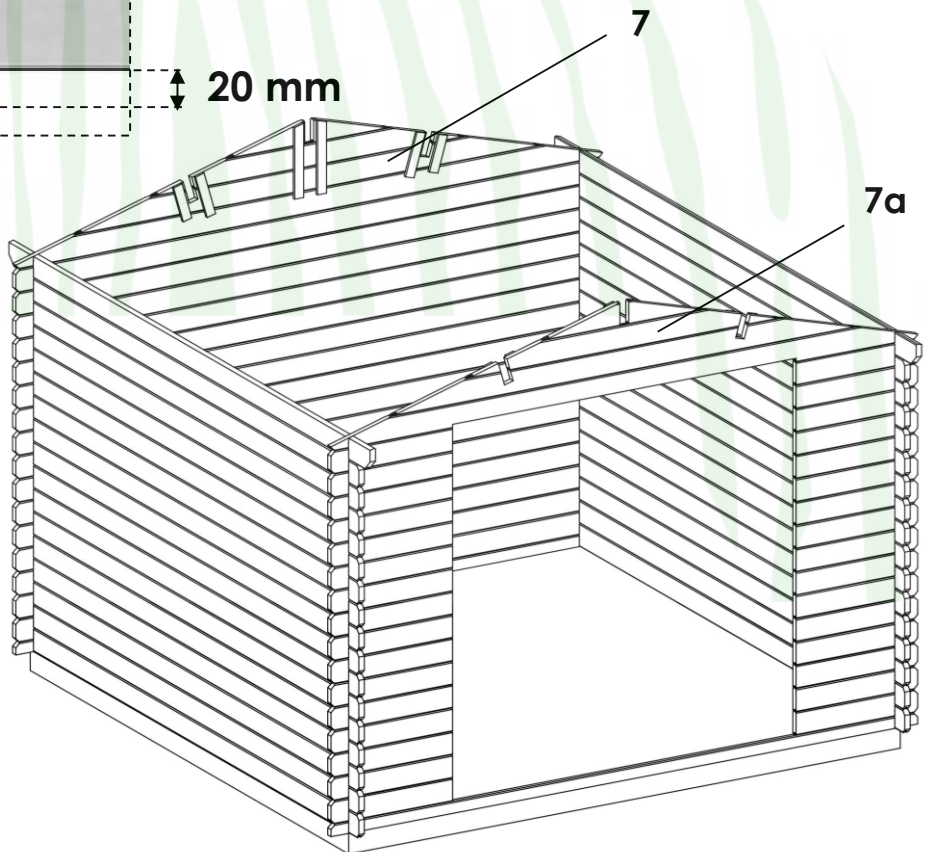
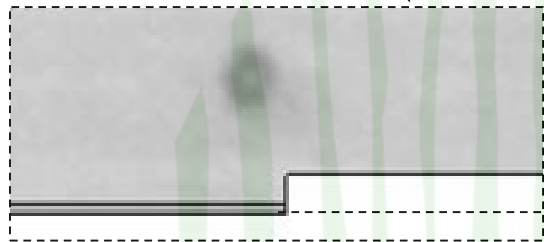
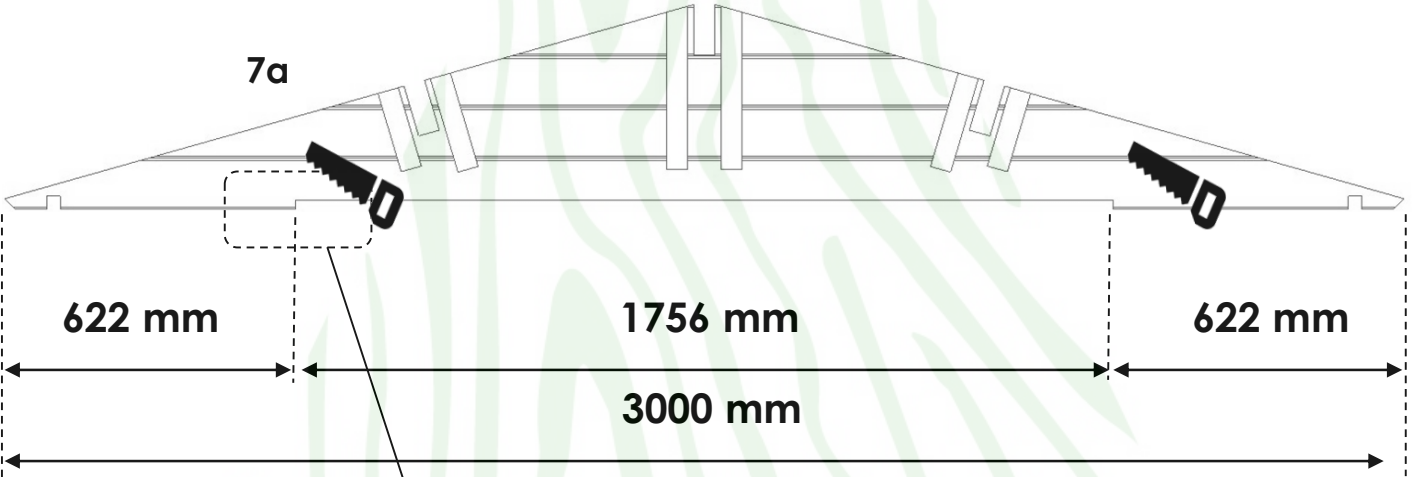
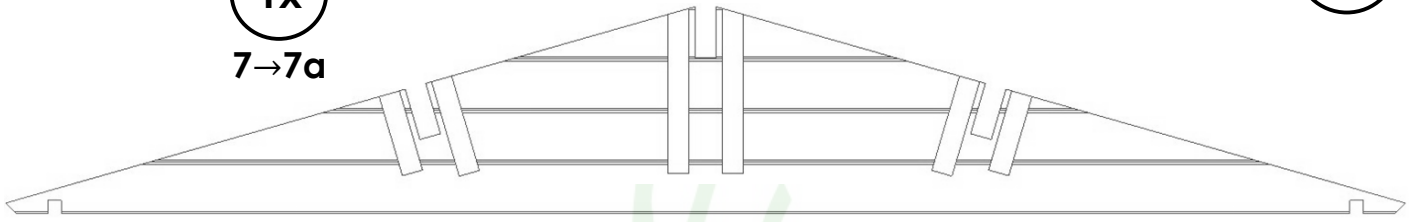

3

1x  
7→7a

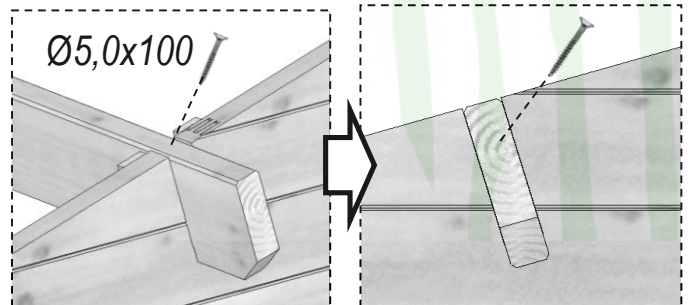
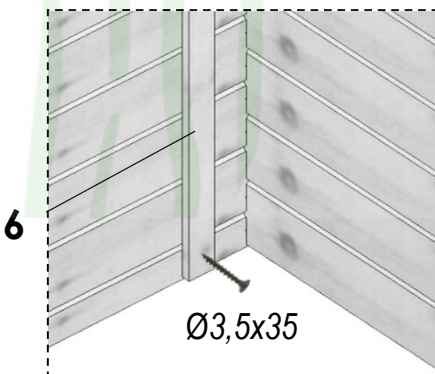
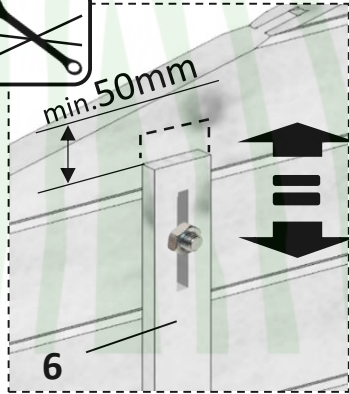
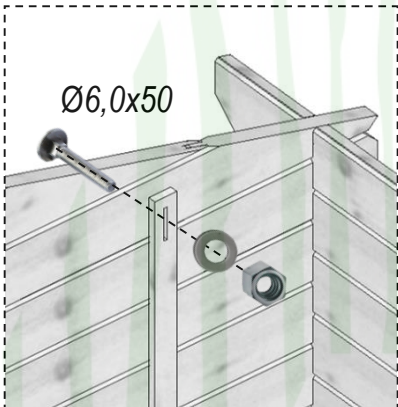
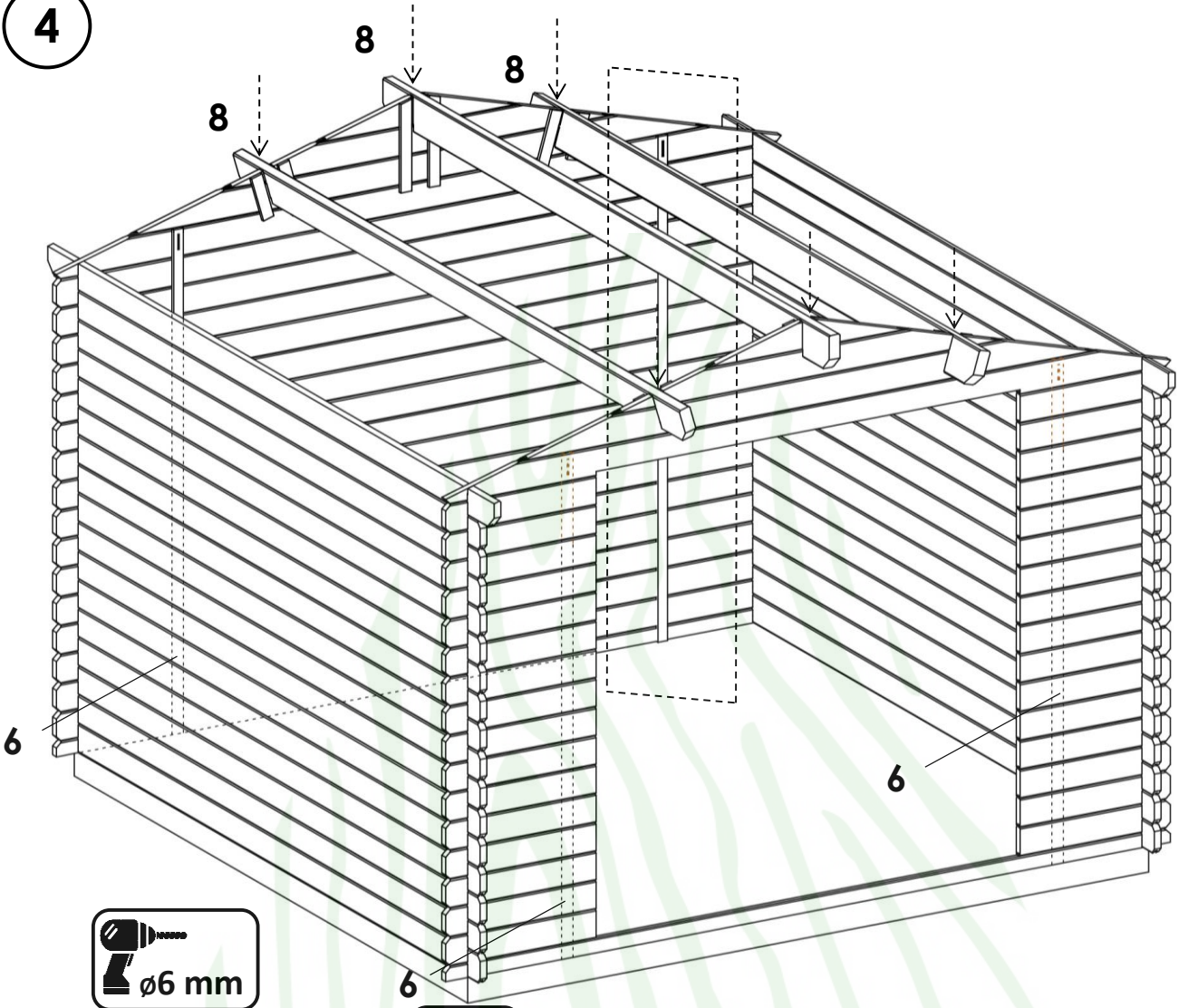

4



- |   |               |
|---|---------------|
|  | Ø5,0x100 (x6) |
|  | Ø6,0x50 (x4)  |
|  | Ø3,5x35 (x4)  |



Ø2,0x40 (x2)

14

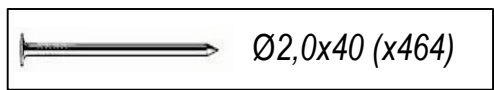
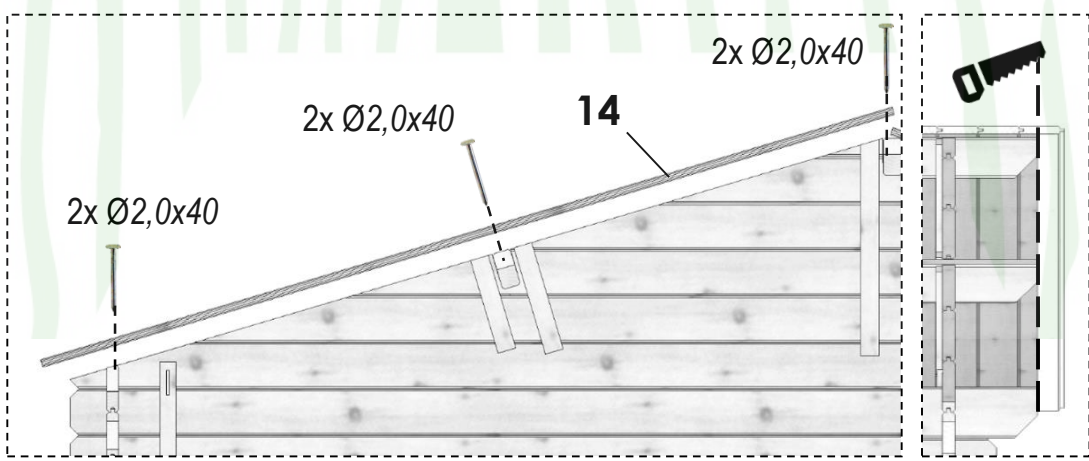
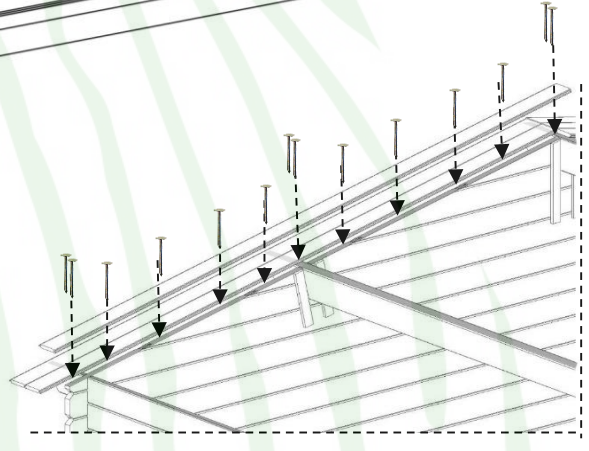
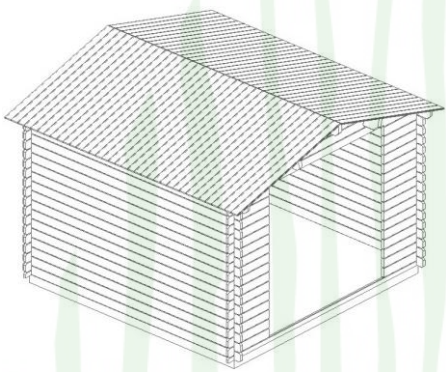
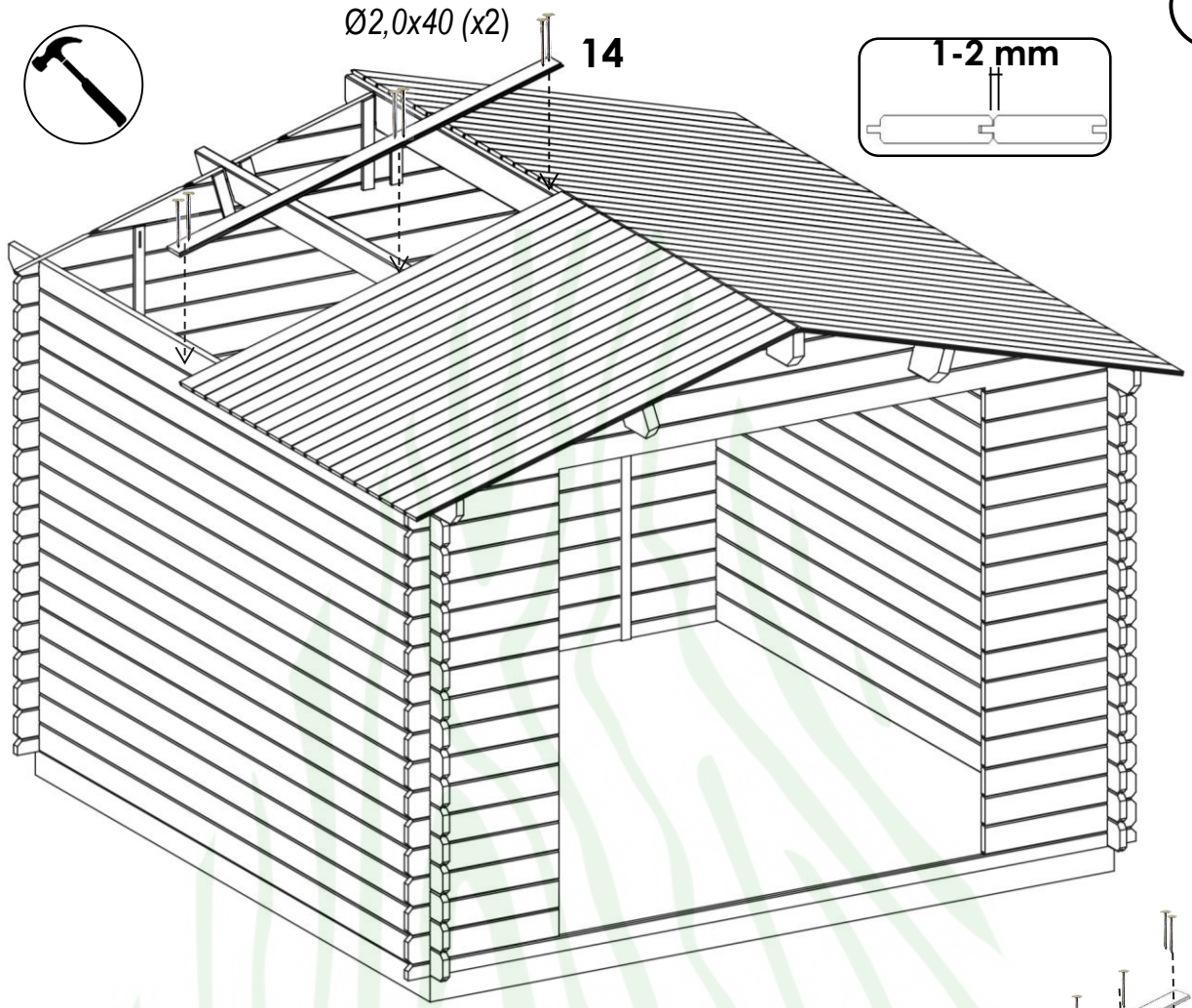
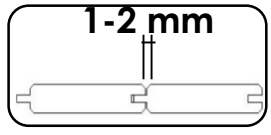

6

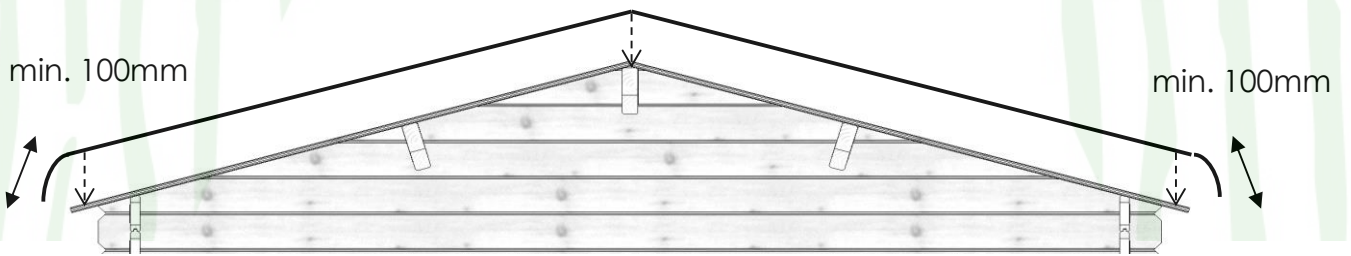
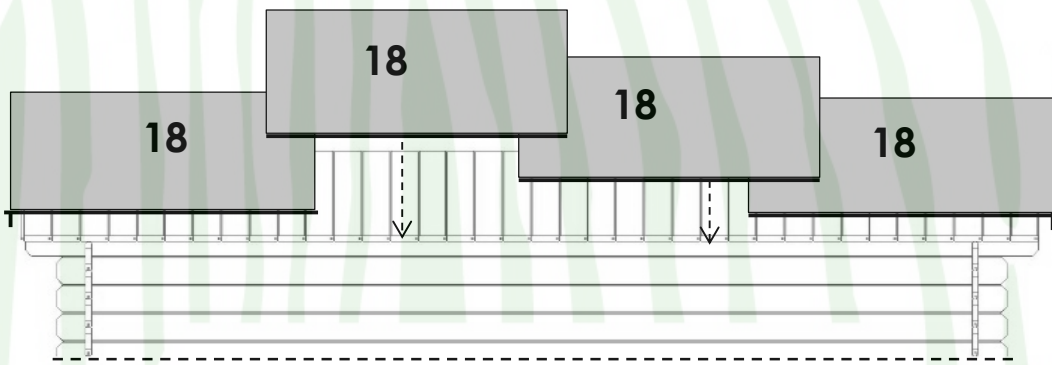
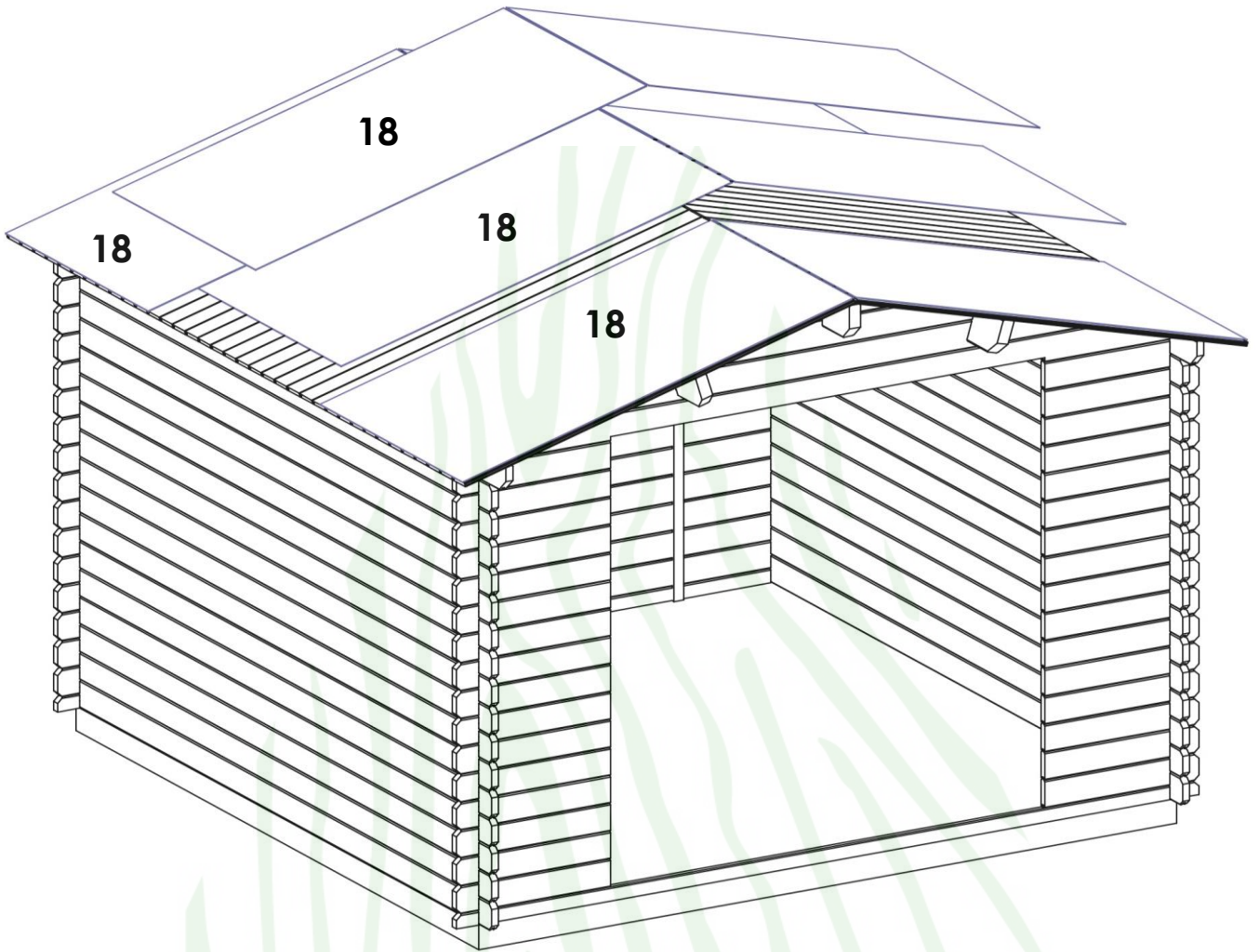

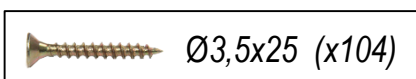
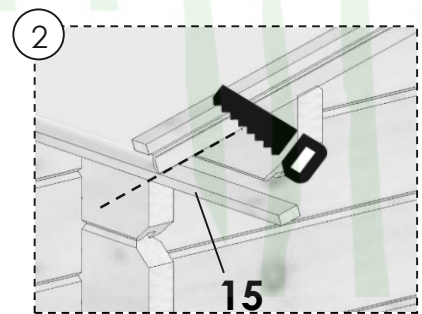
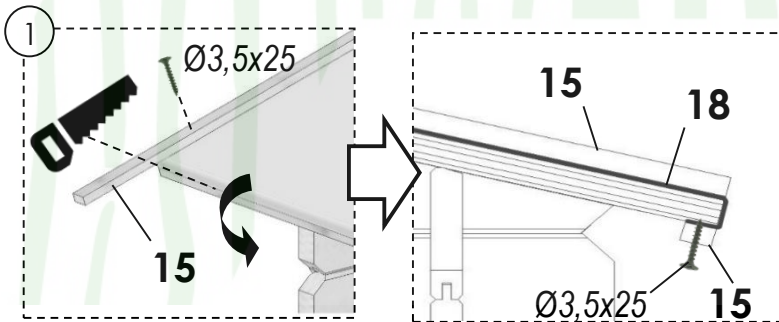
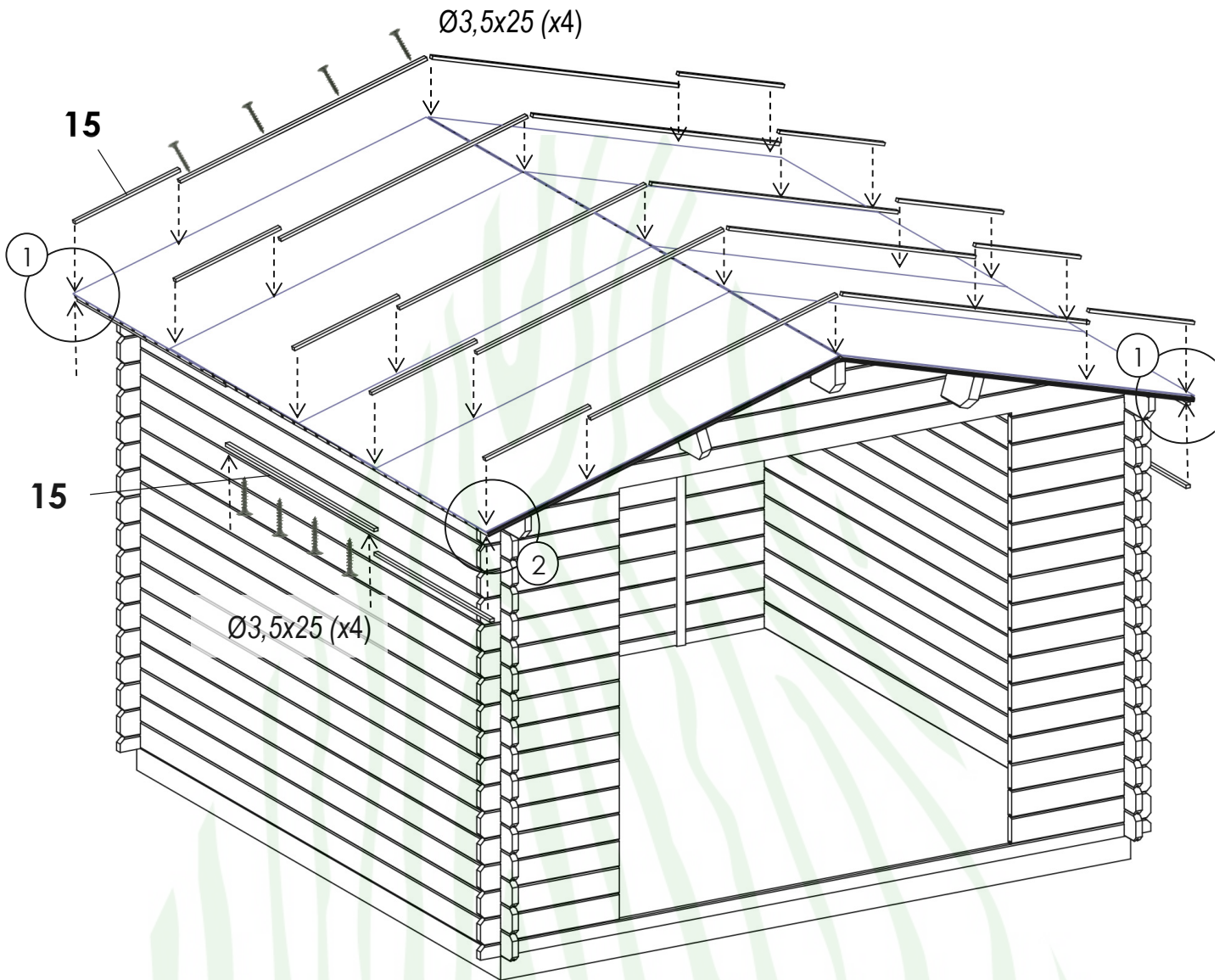

8

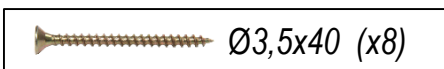
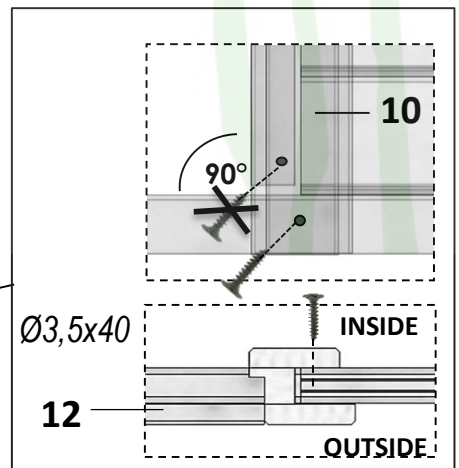
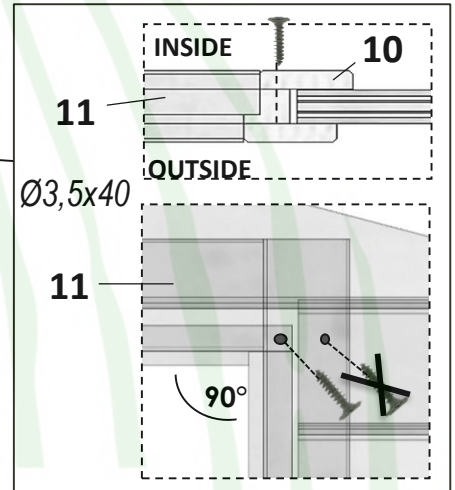
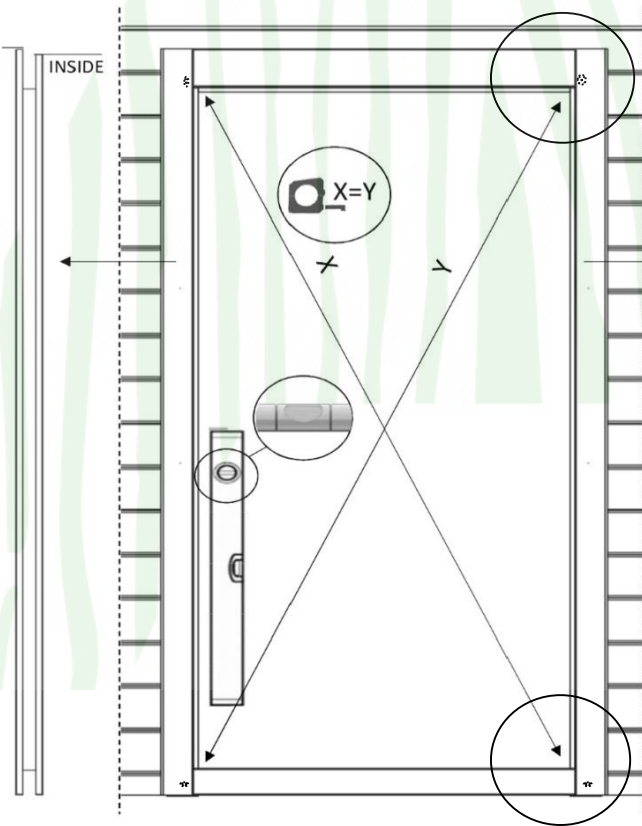
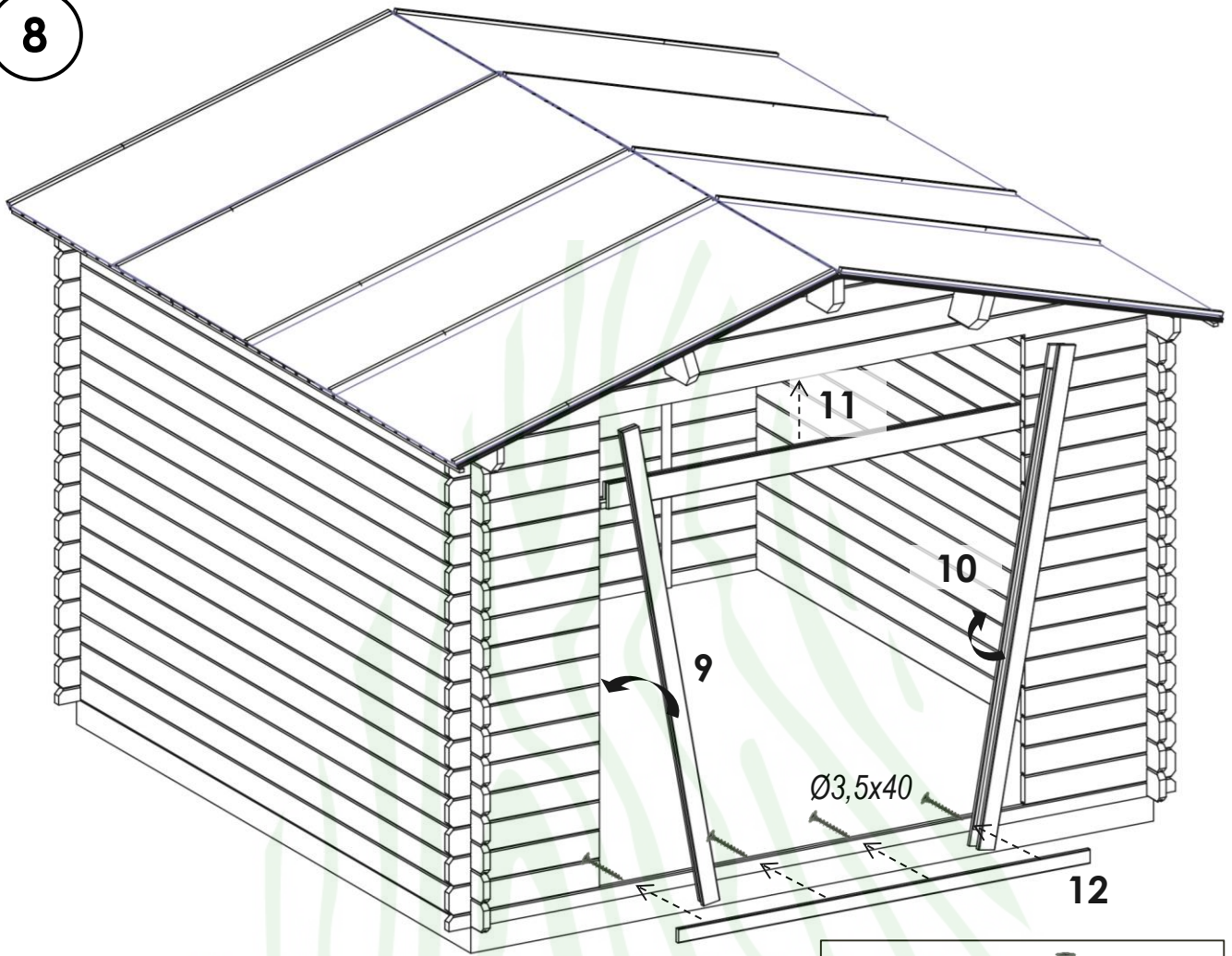

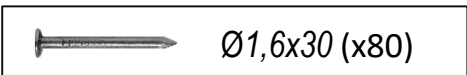
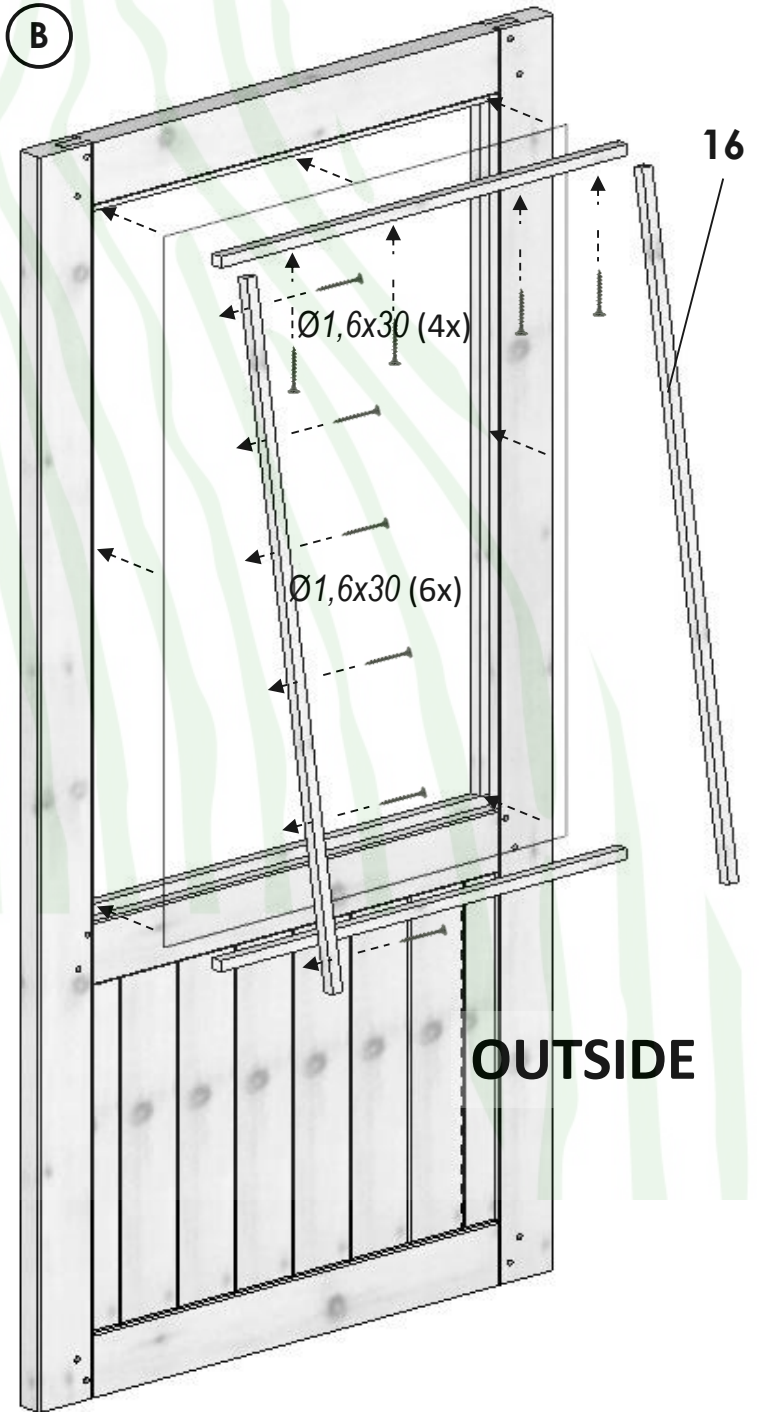
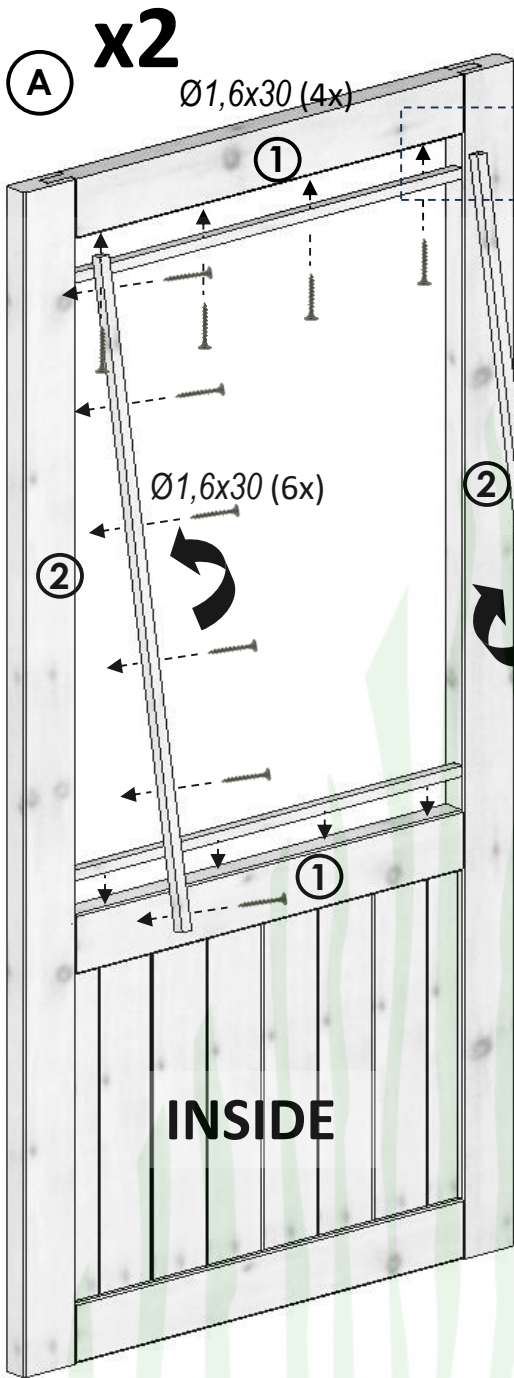

10



x2

Ø1,6x30 (11x)

OUTSIDE

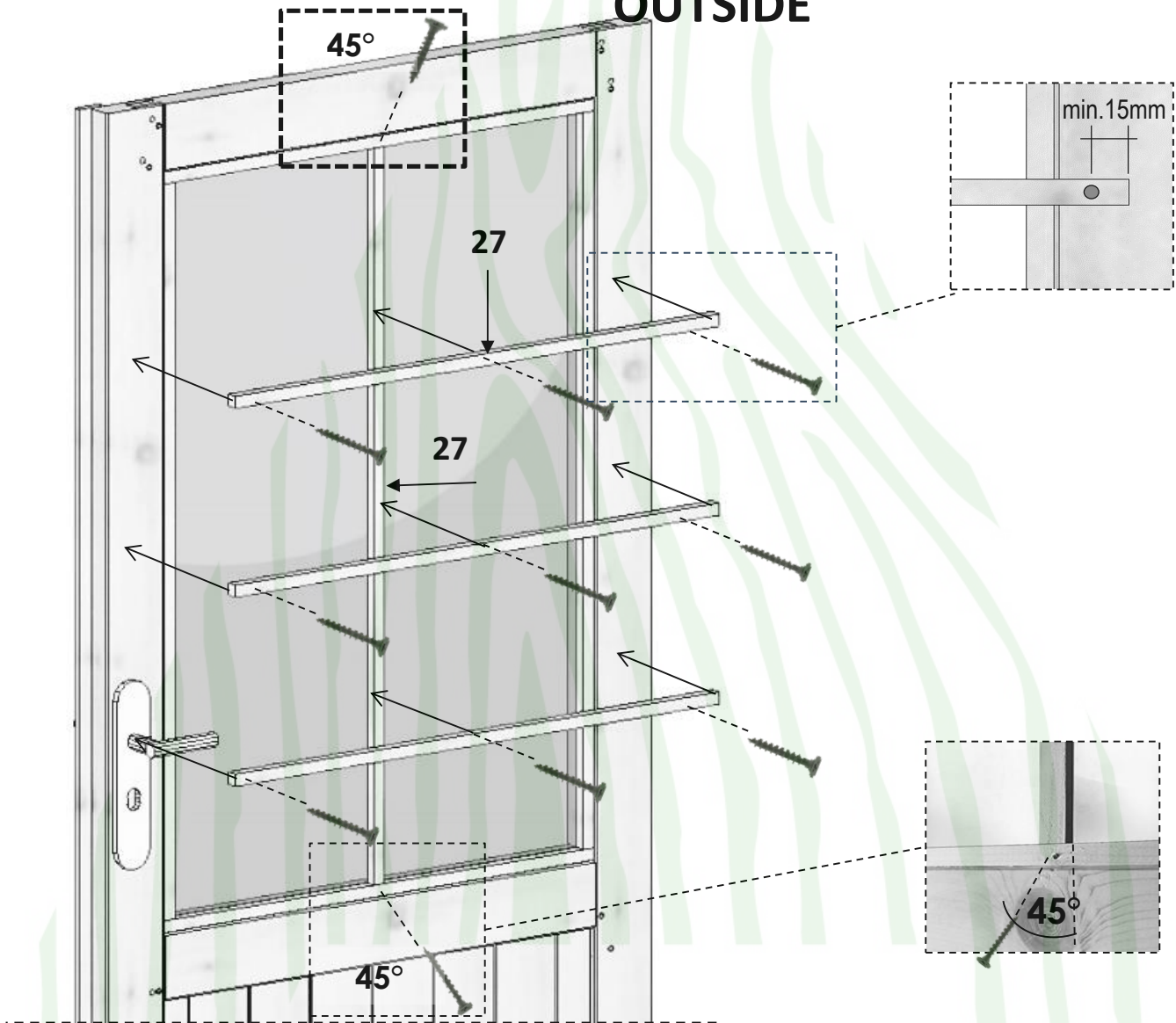

 Ø1,6x30 (x22)

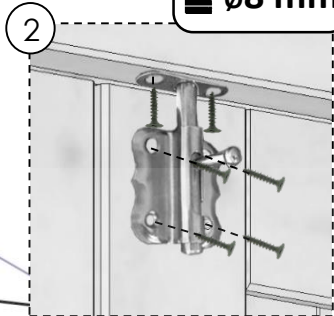

INSIDE Ø3,5x35 (x6)

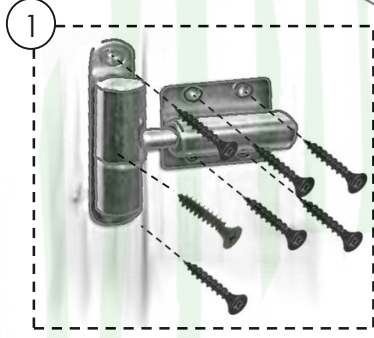
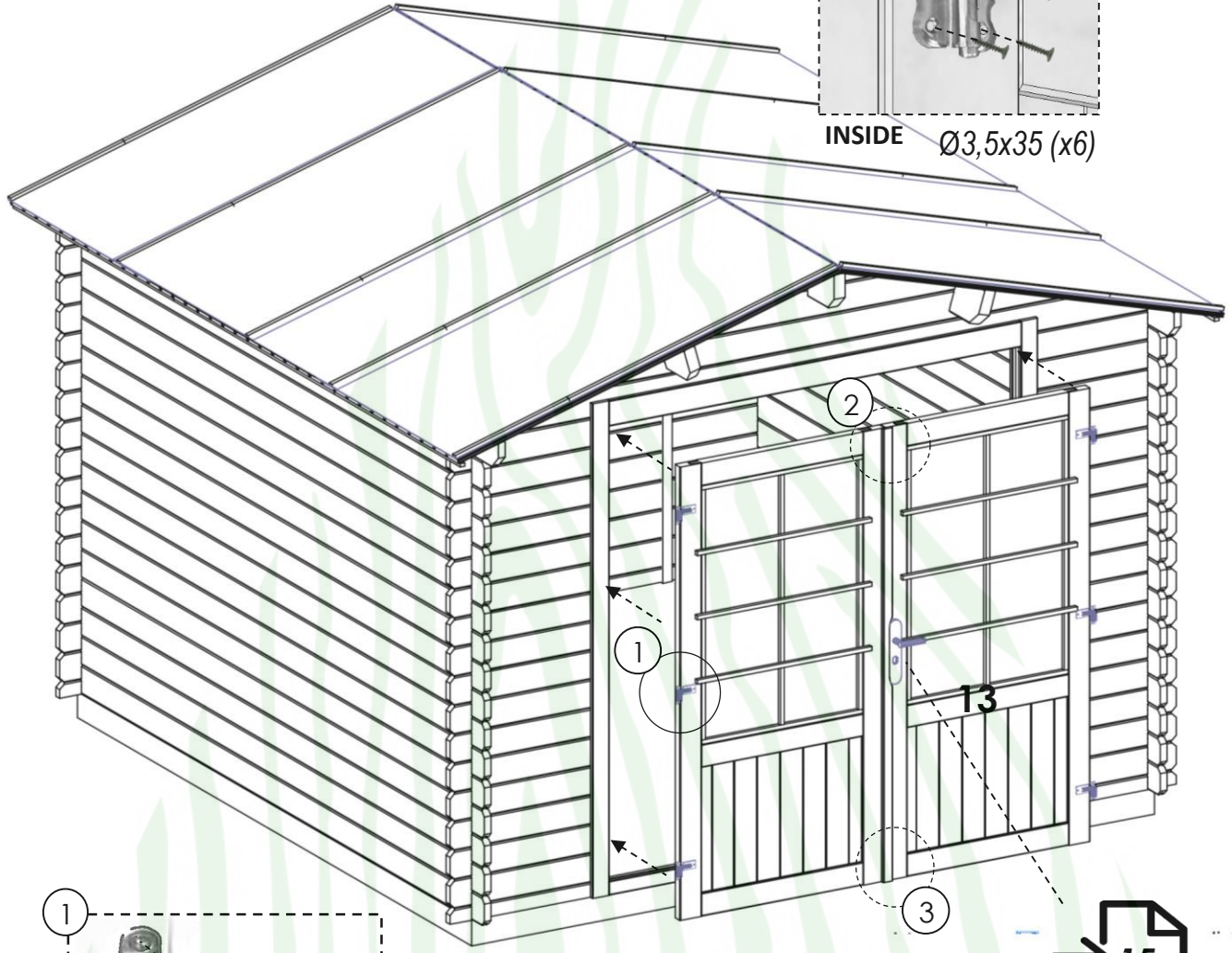

OUTSIDE Ø3,5x35 (x7)

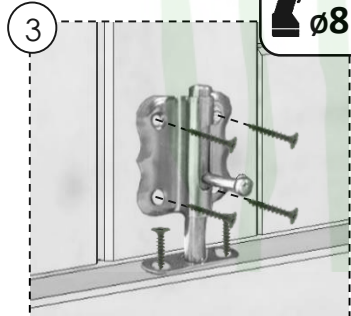
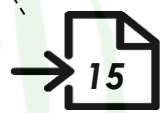

INSIDE Ø3,5x35 (x6)

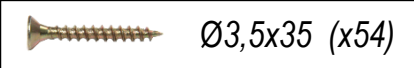

12

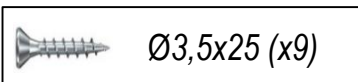
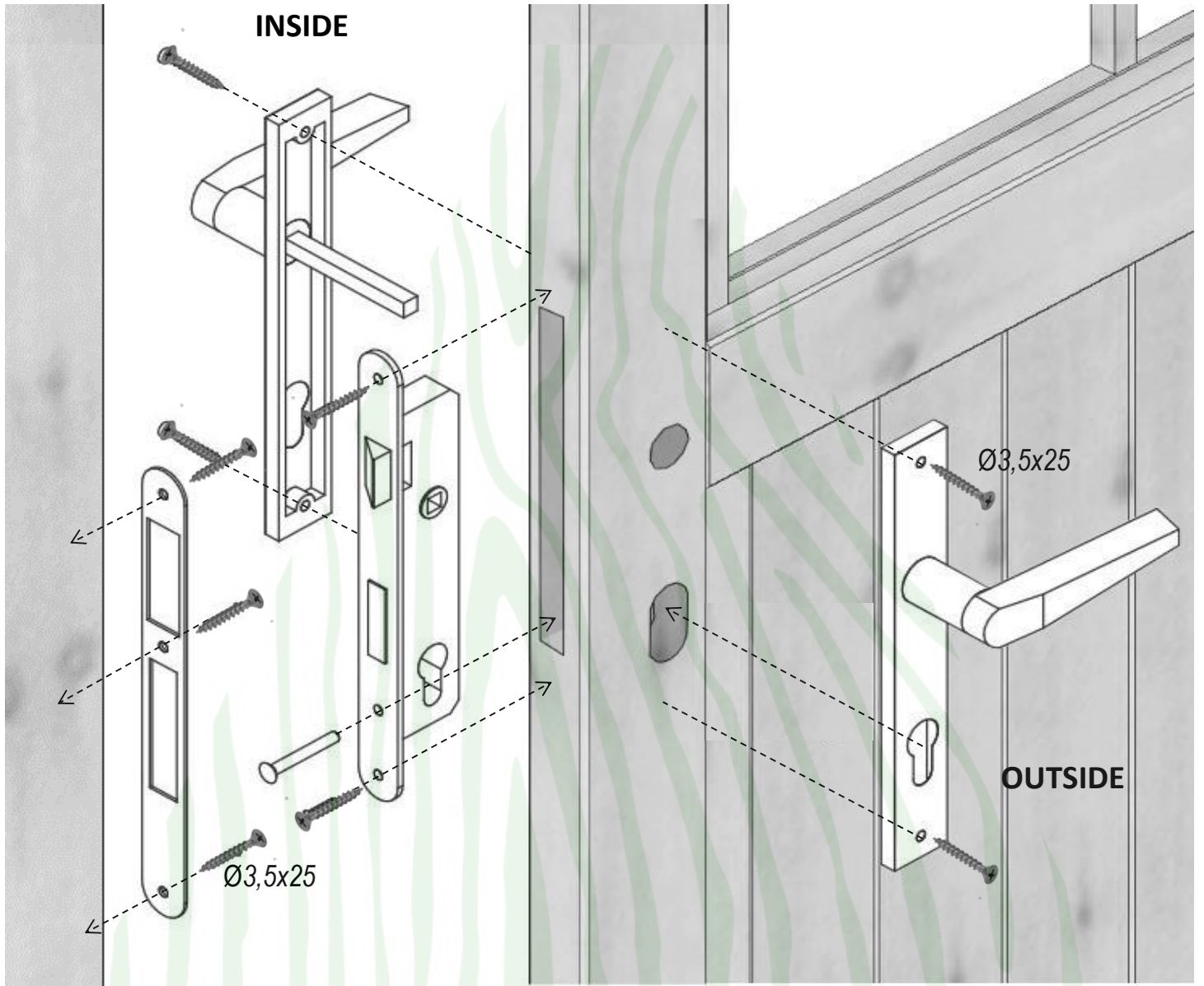

**lock - change from the left to the right**

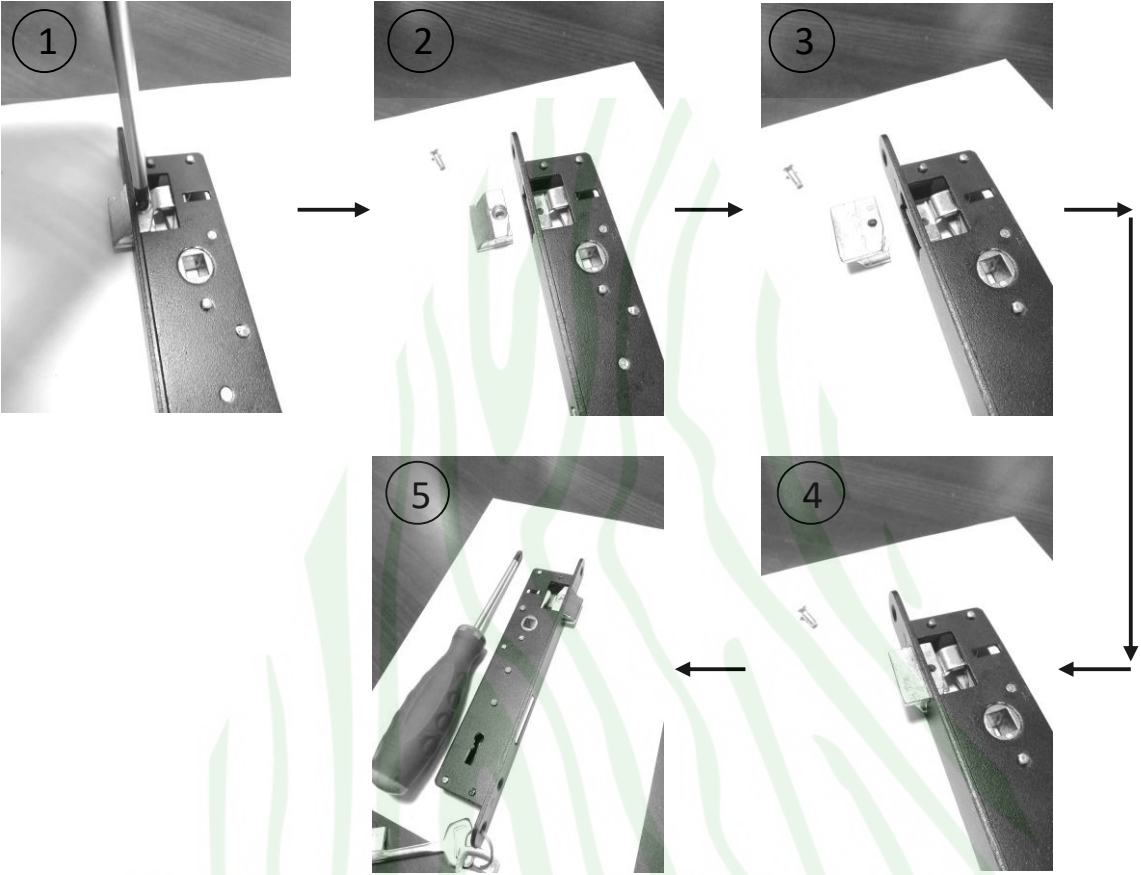

**lock - change from the right to the left**

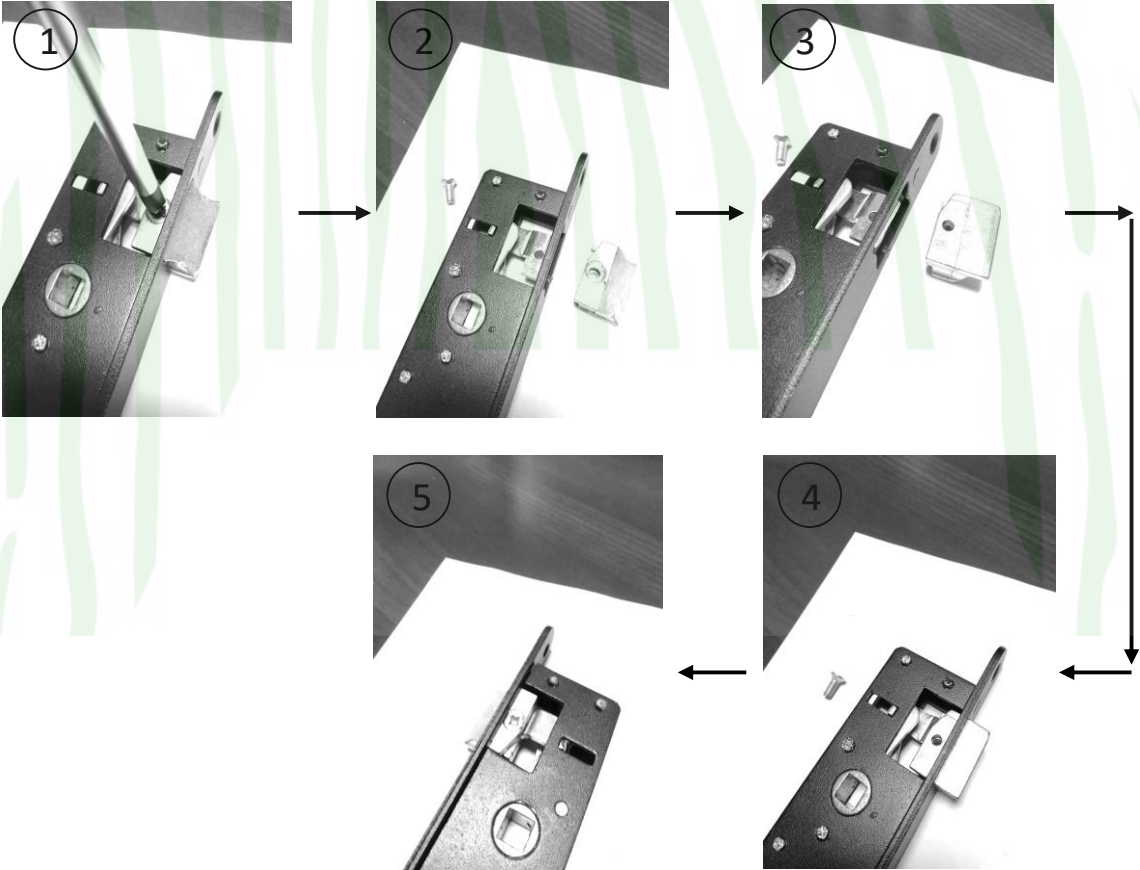

13

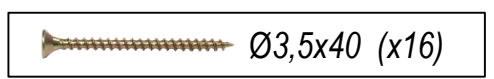
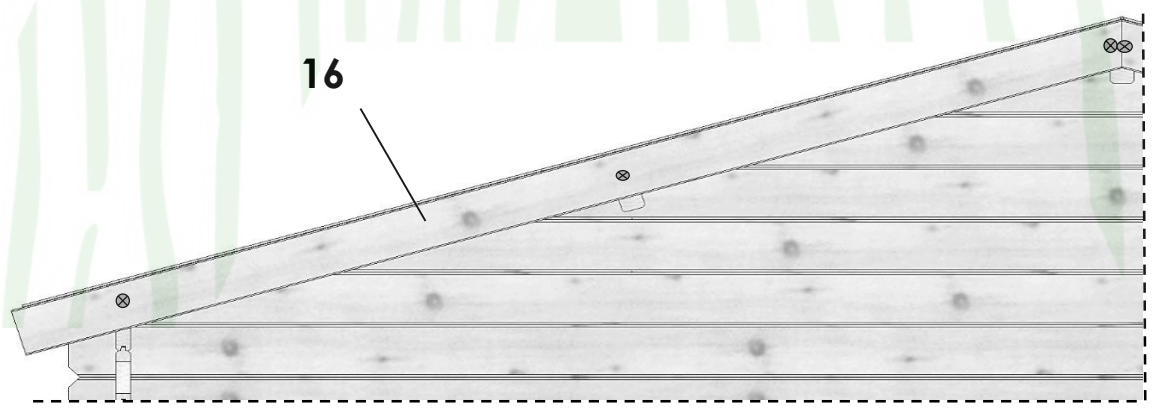
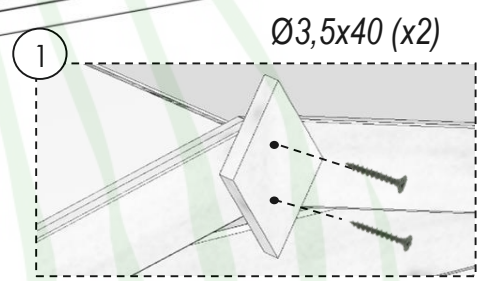
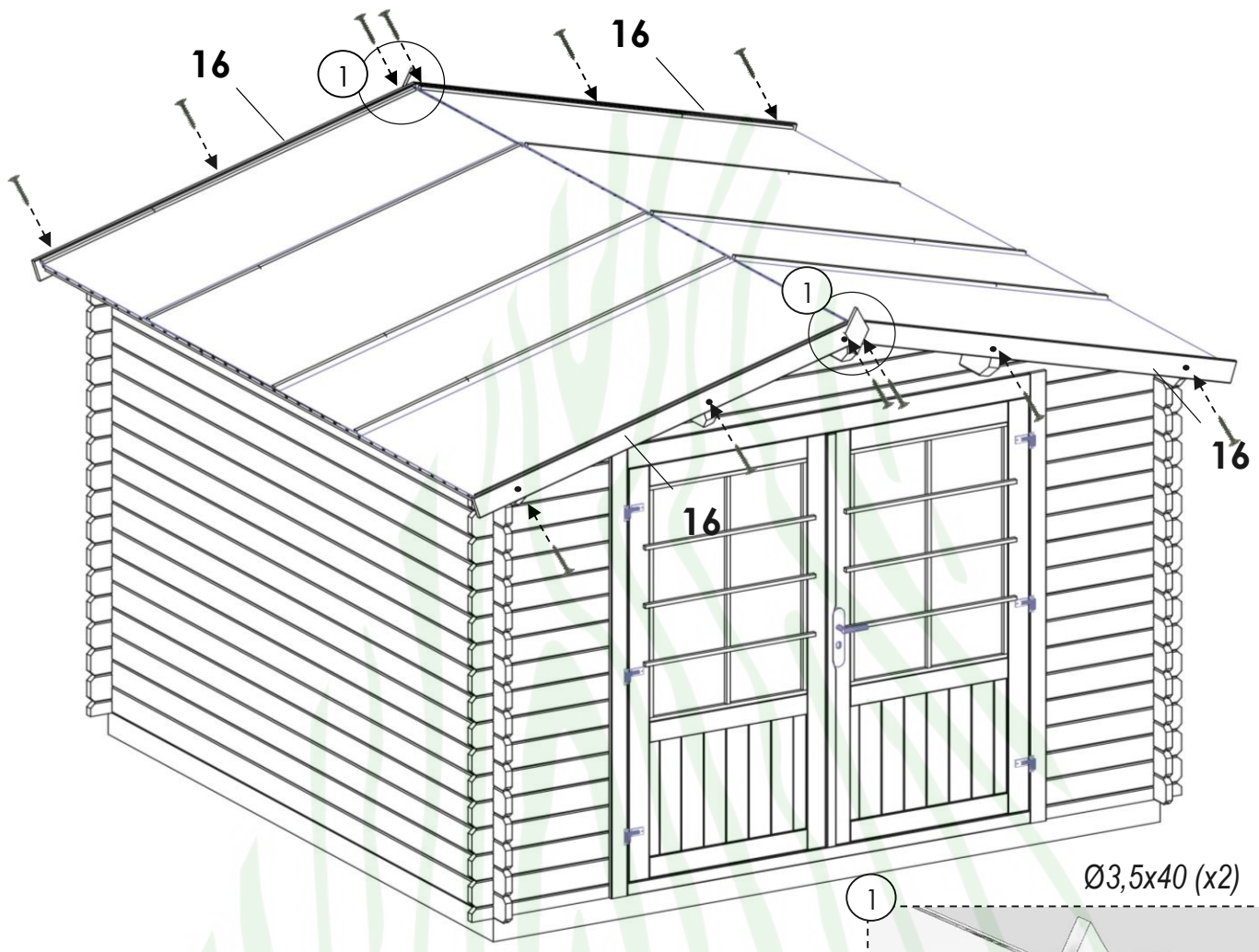

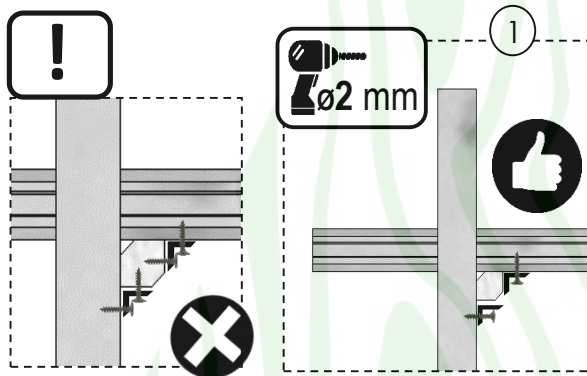
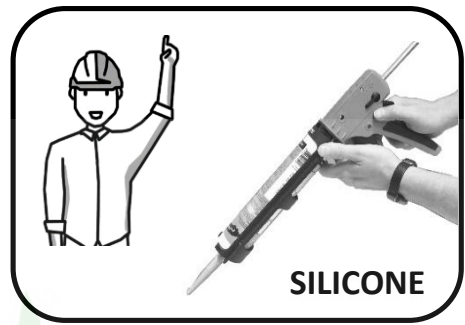
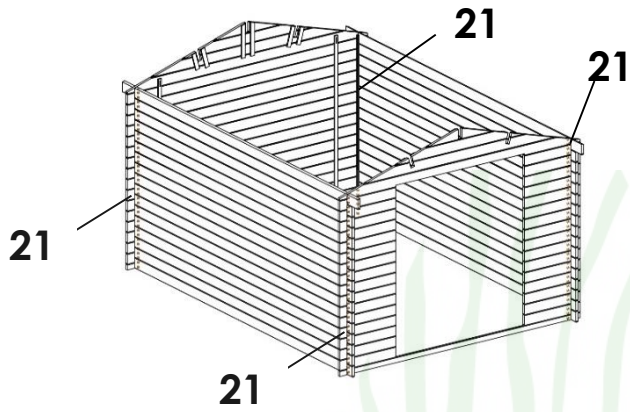

**INSIDE** Ø3,5x25 (x2)  
L15x15 (x2)

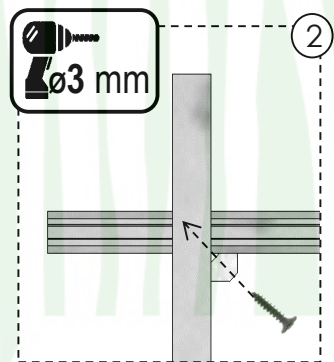

**INSIDE** Ø3,5x40

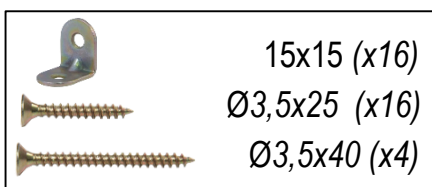
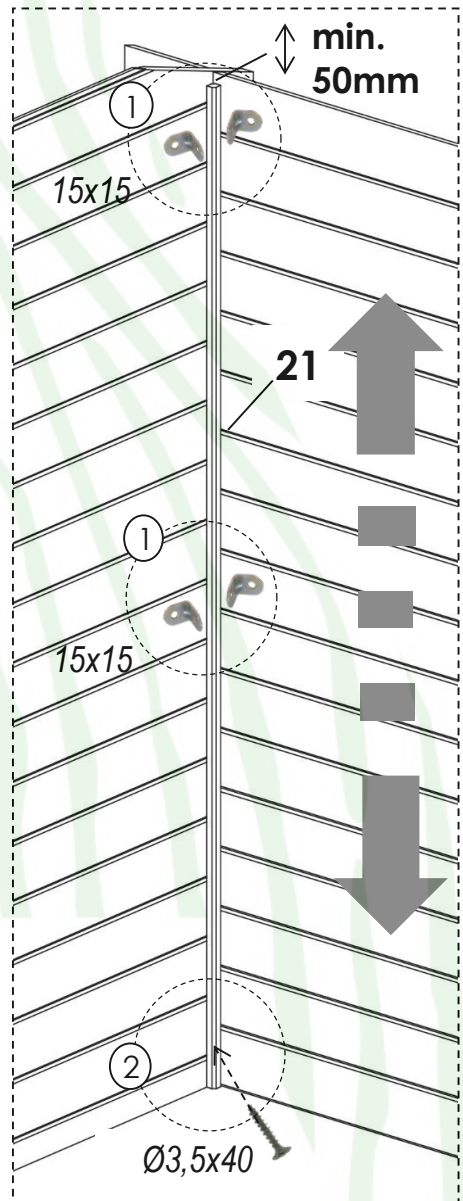

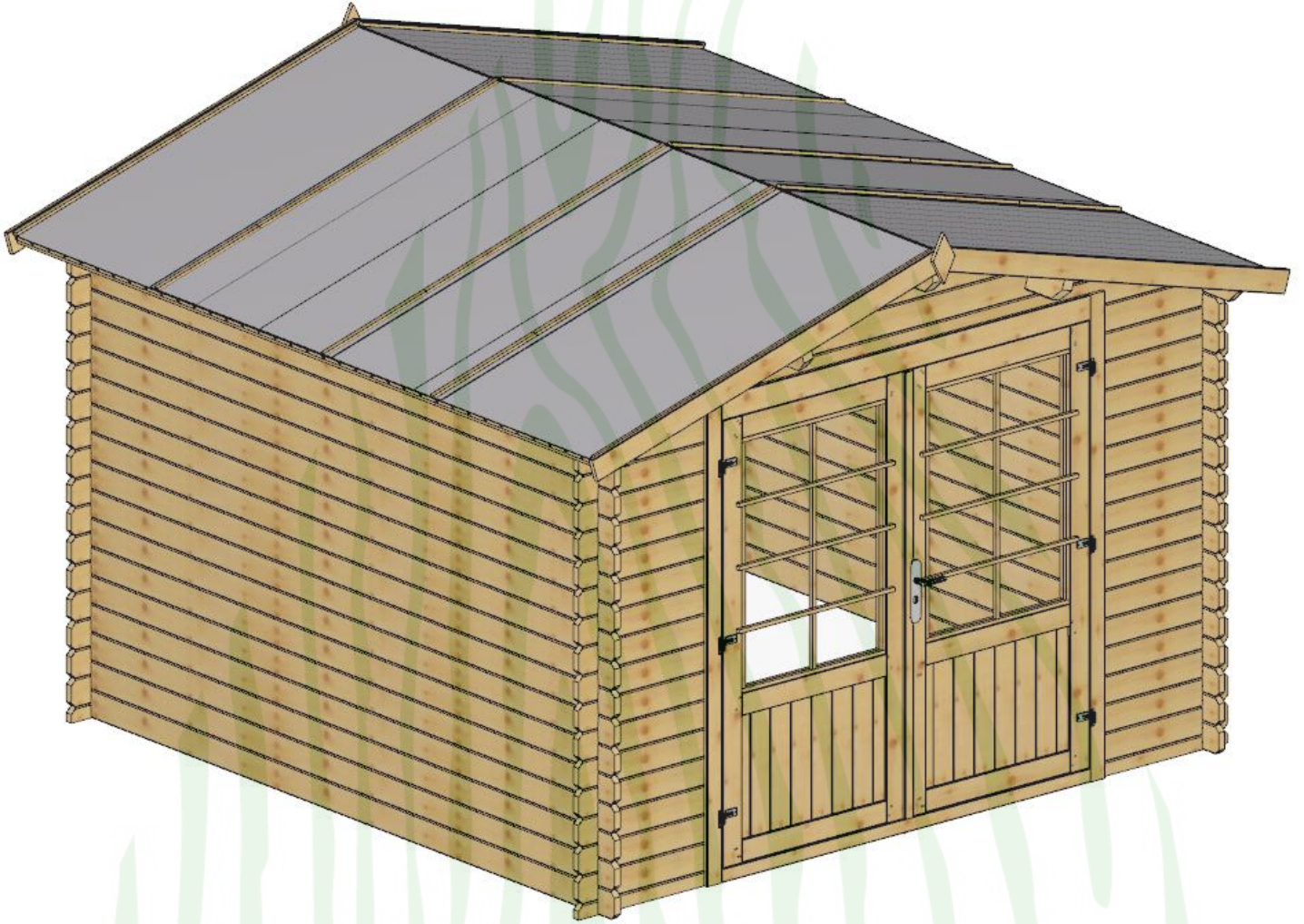

## 300x200cm 28mm



DOM141-1 300x200cm

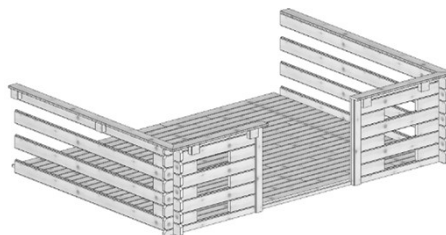

DOM142-1 300x200cm

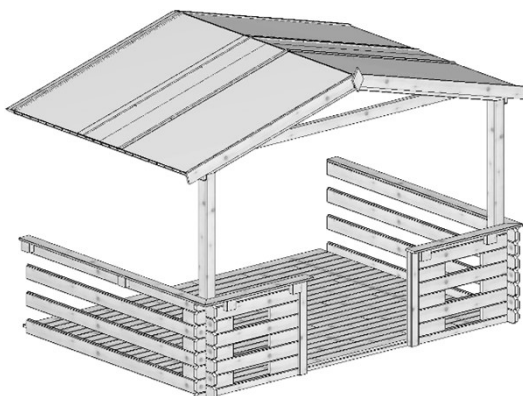

## 300x300cm 28mm

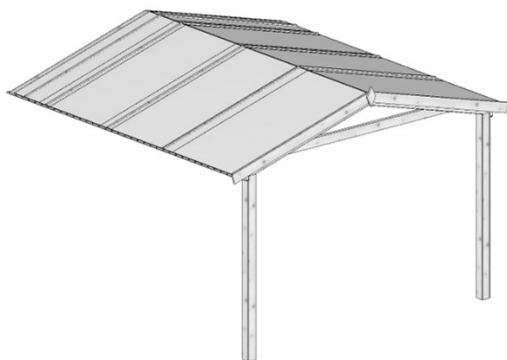

DOM32-2 300x300cm

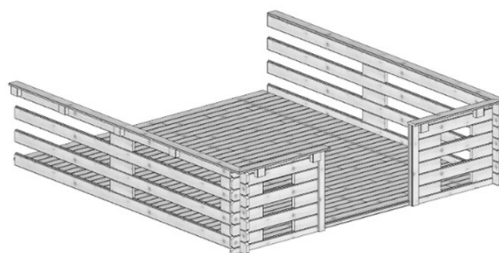

DOM395-1 300x300cm

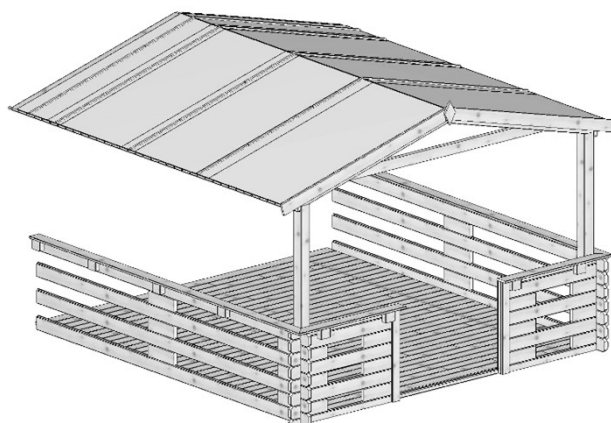

## 400x200cm 28mm

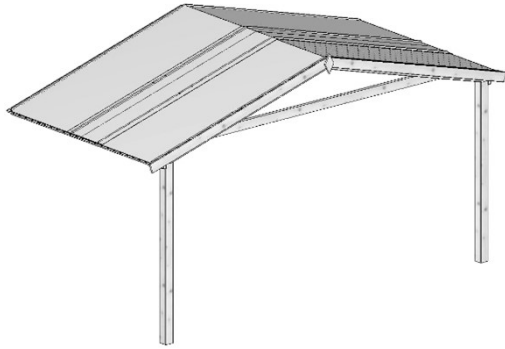

**DOM 17-1 400x200cm**

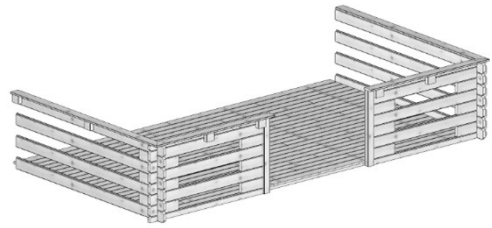

**DOM18-1 400x200cm**

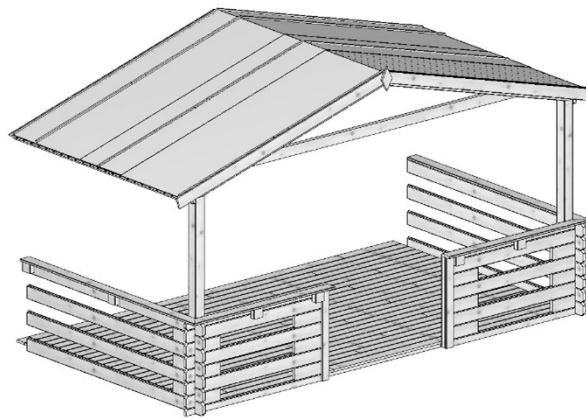

## 400x300cm 28mm

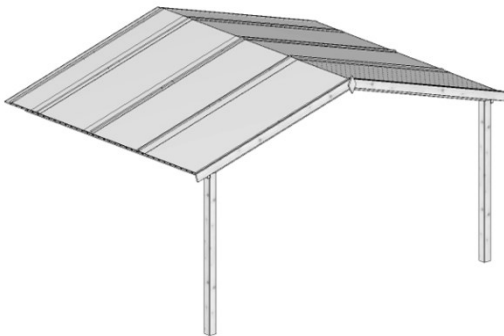

**DOM392-1 400x300cm**

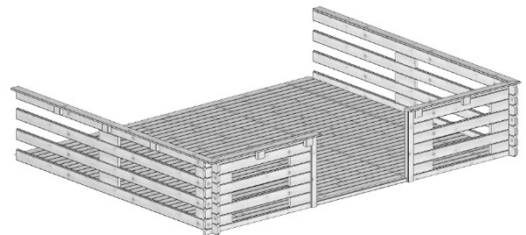

**DOM393-1 400x300cm**

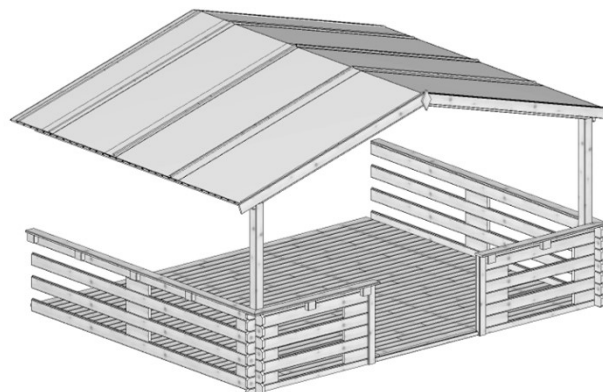

**300x200cm 28mm**

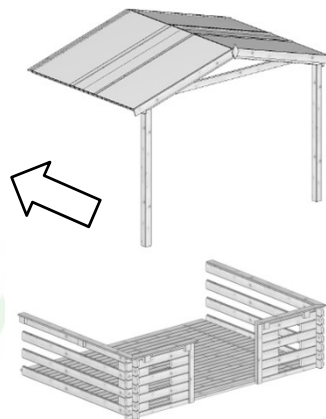
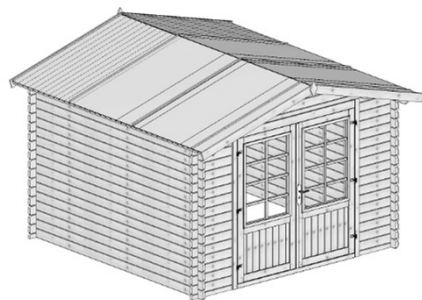

**300x300cm 28mm**

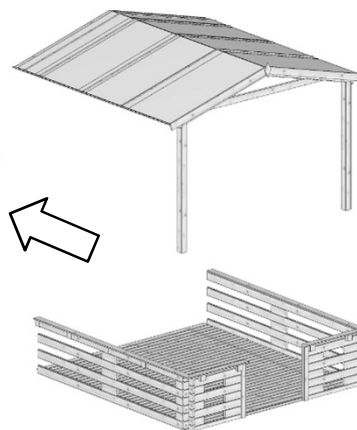
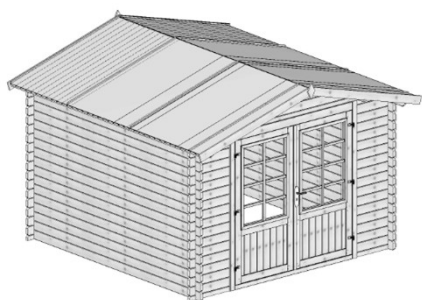



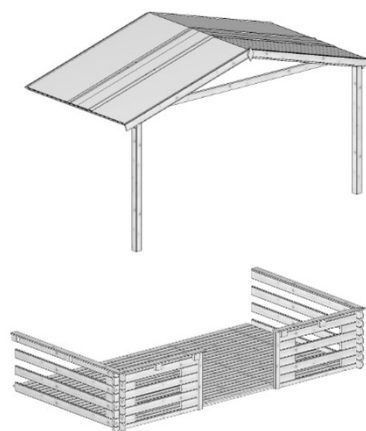
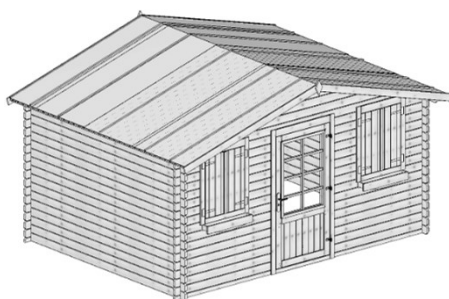



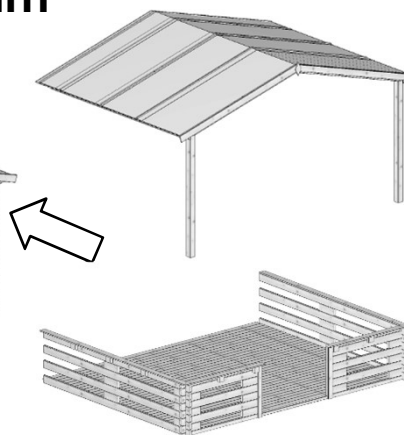
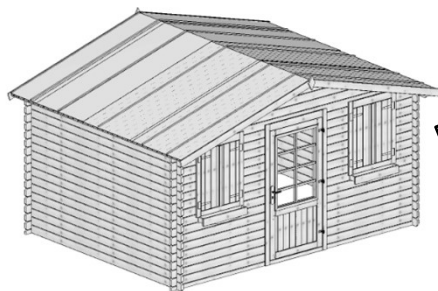





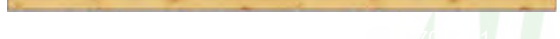







**400x200cm 28mm**



**400x300cm 28mm**







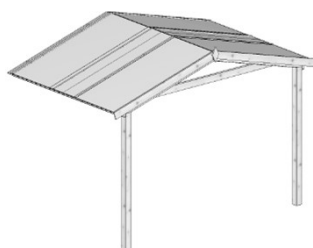

















## DOM141-1 300x200cm 28mm

nr.	element	[mm]	[mm]	[mm]	szt.	A	B
1		38	90	1489	2		
2		38	90	2340	1		
3		28	113	2000	2		
4		38	90	1962	3		
5		90	90	1908	2		
6		16	99	1640	46		
7		16	95	1680	2		
8		13	22	1150	18		
9		16	110	165	1		
10		3	1000	3500	2		
11		3	500	3500	1		
A		3,5 x 25			72		
B		3,5 x 40			16		
C		3,5 x 50			12		
D		4 x 30			104		
E		4 x 70			14		
F		5 x 100			3		
G		38 x 70			6		
H		6,0 x 140			1		
J		6,0 x 90			4		
K		2,0 x 40			276		
L		40x40x1,5			3		







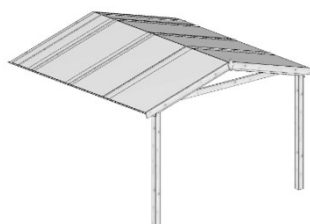















## DOM32-2 300x300cm 28mm

nr.	element	[mm]	[mm]	[mm]	szt.	A	B
1		38	90	1489	2		
2		38	90	2340	1		
3		28	113	3000	2		
4		38	90	2962	3		
5		90	90	1908	2		
6		16	99	1640	70		
7		16	95	1680	2		
8		13	22	1150	26		
9		16	110	165	1		
10		3	1000	3500	3		
11		3	500	3500	1		
A		3,5 x 25			104		
B		3,5 x 40			16		
C		3,5 x 50			12		
D		4 x 30			104		
E		4 x 70			14		
F		5 x 100			3		
G		38 x 70			6		
H		6,0 x 140			1		
J		6,0 x 90			4		
K		2,0 x 40			420		
L		40x40x1,5			3		



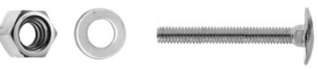



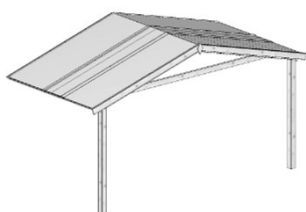

















## DOM17-1 400x200cm 28mm

nr.	element	[mm]	[mm]	[mm]	szt.	A	B
1		38	90	2013	2		
2		38	90	3200	1		
3		28	113	2000	2		
4		38	90	1962	3		
5		90	90	1908	2		
6		16	99	2160	46		
7		16	95	2200	2		
8		13	22	1150	20		
9		16	110	165	1		
10		3	1000	4500	2		
11		3	500	4500	1		
A		3,5 x 25			80		
B		3,5 x 40			16		
C		3,5 x 50			12		
D		4 x 30			104		
E		4 x 70			14		
F		5 x 100			3		
G		38 x 70			6		
H		6,0 x 140			1		
J		6,0 x 90			4		
K		2,0 x 40			276		
L		40x40x1,5			3		



## DOM392-1 400x300cm 28mm

nr.	element	[mm]	[mm]	[mm]	szt.	A	B
1		38	90	2013	2		
2		38	90	3200	1		
3		28	113	3000	2		
4		38	90	2962	3		
5		90	90	1908	2		
6		16	99	2160	70		
7		16	95	2200	2		
8		13	22	1150	26		
9		16	110	165	1		
10		3	1000	4500	3		
11		3	500	4500	1		
A		3,5 x 25			104		
B		3,5 x 40			16		
C		3,5 x 50			12		
D		4 x 30			104		
E		4 x 70			14		
F		5 x 100			3		
G		38 x 70			6		
H		6,0 x 140			1		
J		6,0 x 90			4		
K		2,0 x 40			420		
L		40x40x1,5			3		

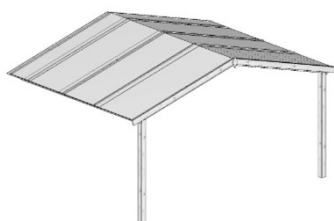

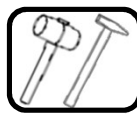

1

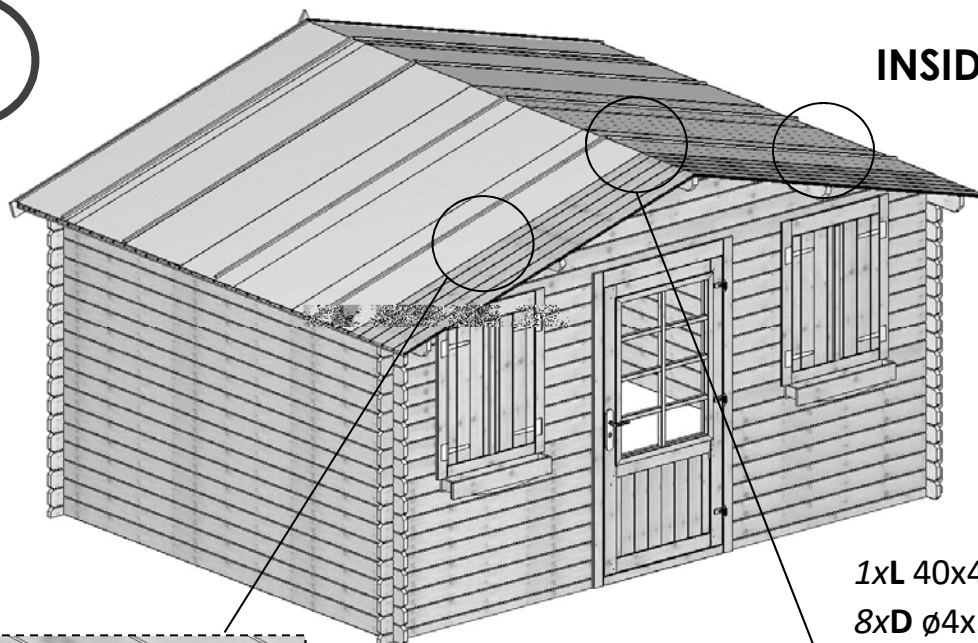

INSIDE

1xL 40x40x1,5  
8xD ø4x30

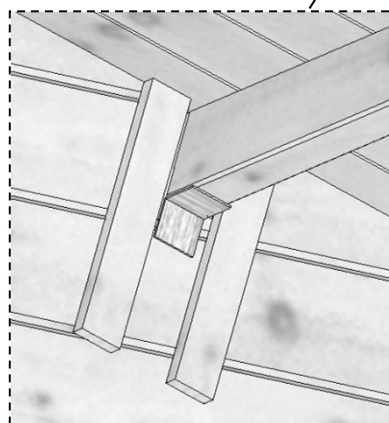

1xL 40x40x1,5 **INSIDE**  
8xD ø4x30

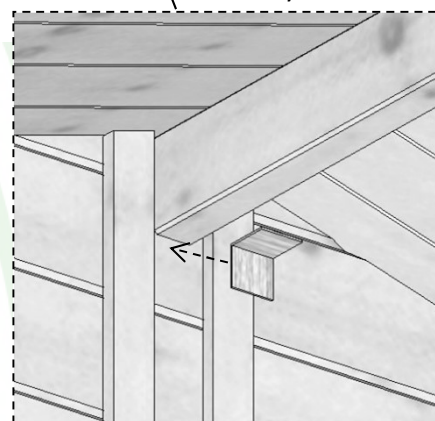

**INSIDE**

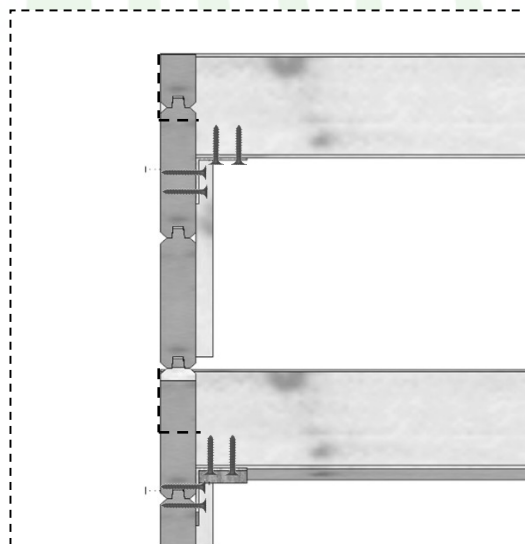

3xL 40x40x1,5

24xD ø4x30

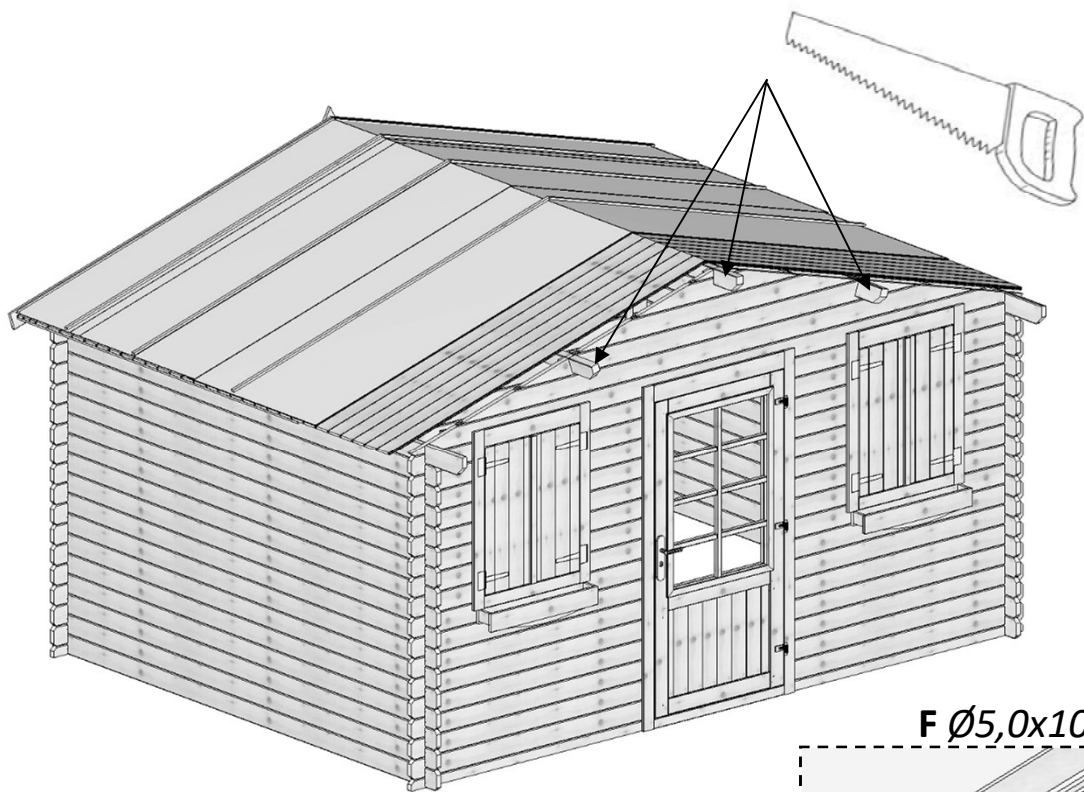

F Ø5,0x100

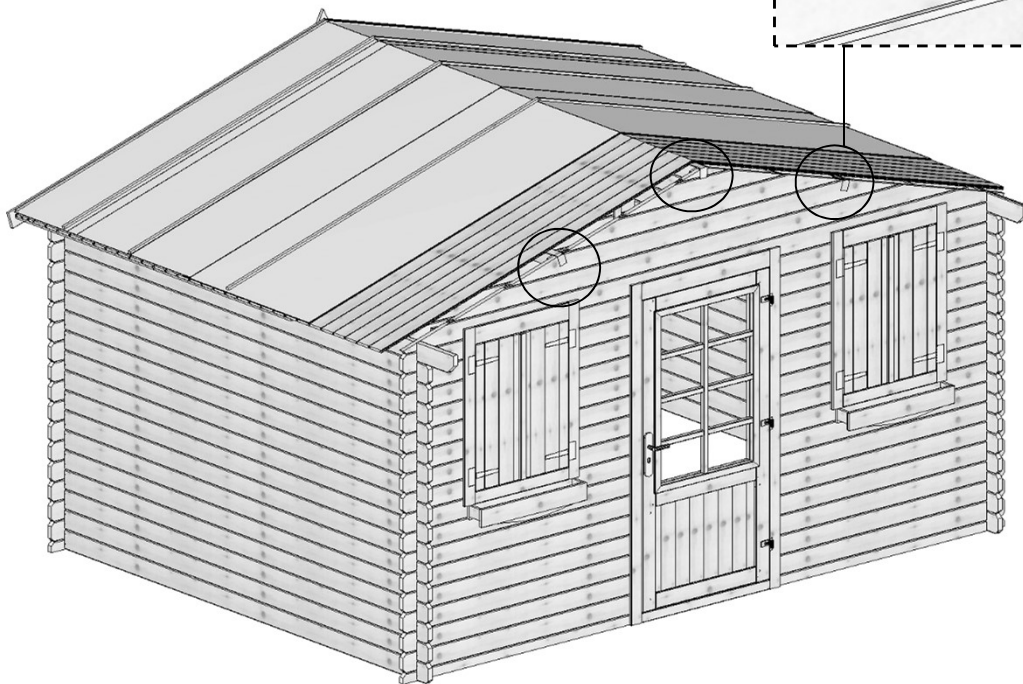
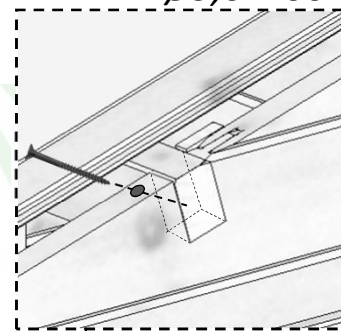
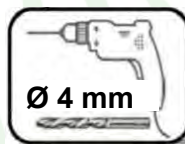

**DOM141-1 DOM32-2**

**2**

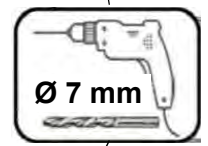
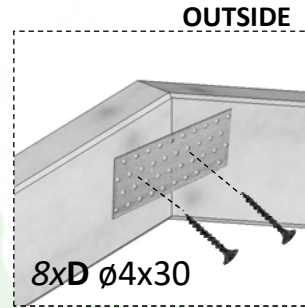
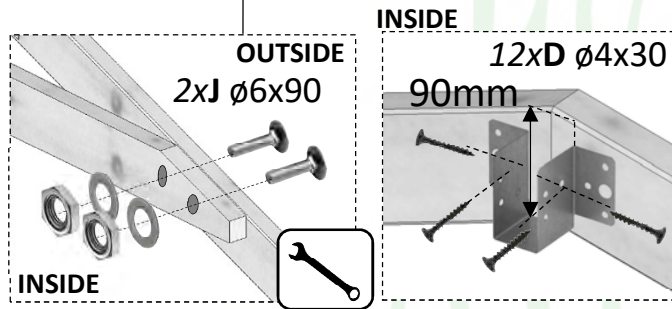
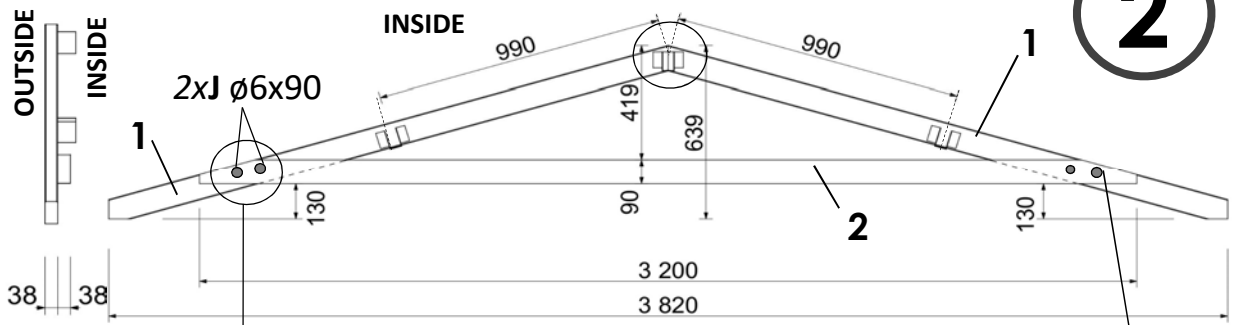

**DOM17-1 DOM392-1**

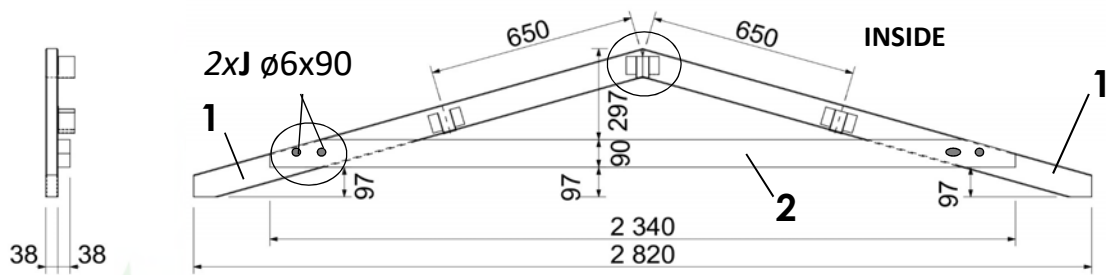

**3**

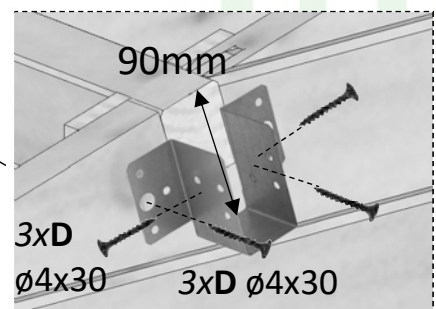
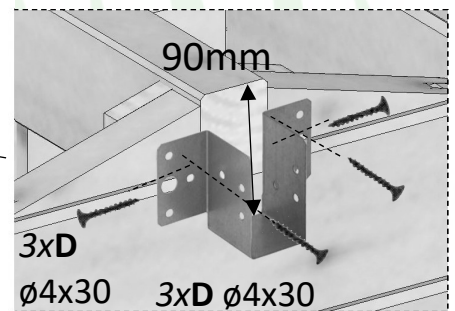
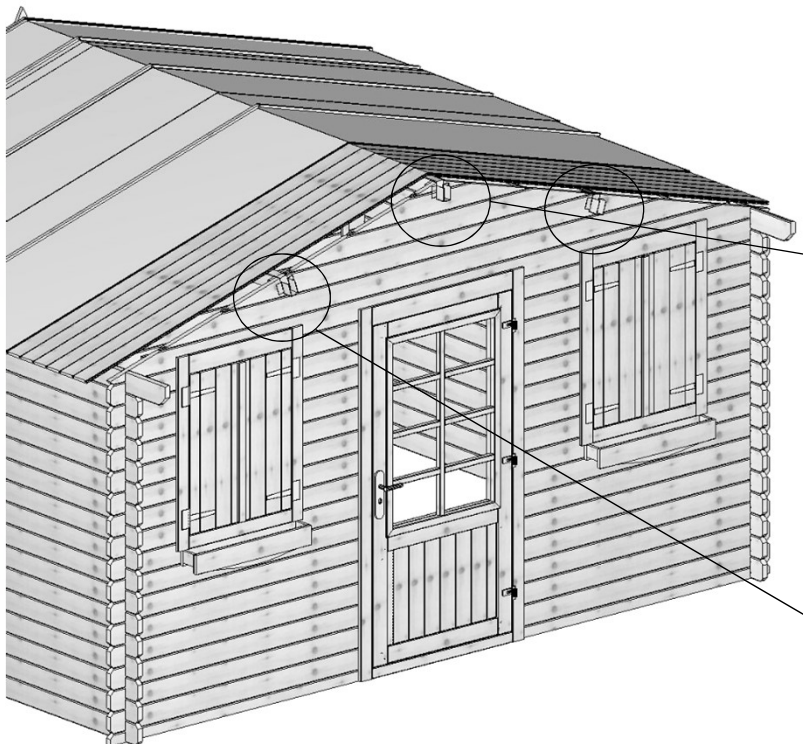

# 4

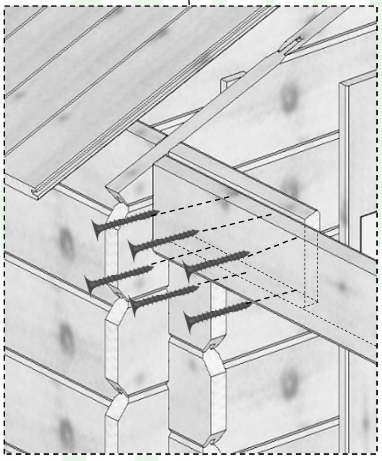
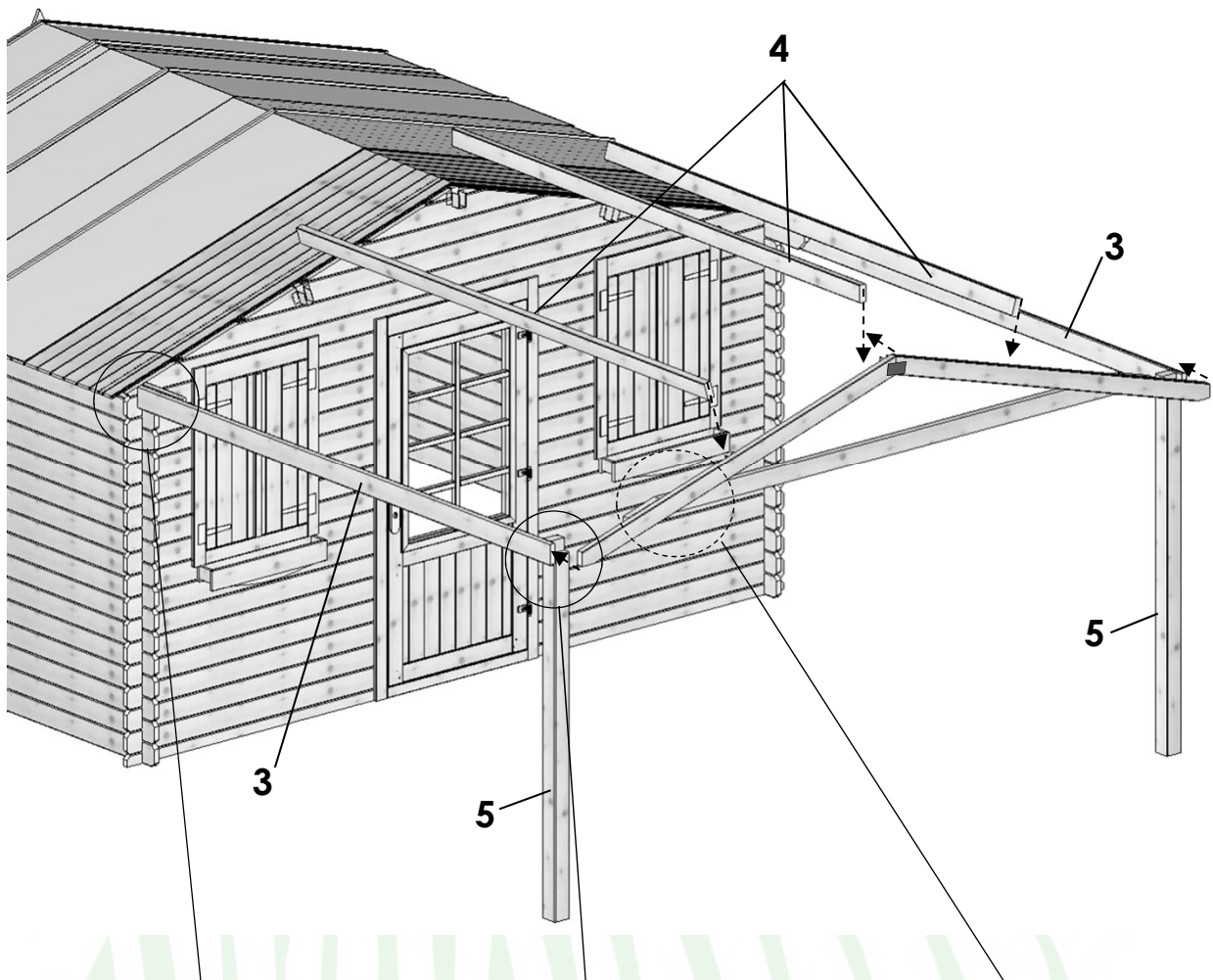

6xC  $\phi 3,5 \times 50$

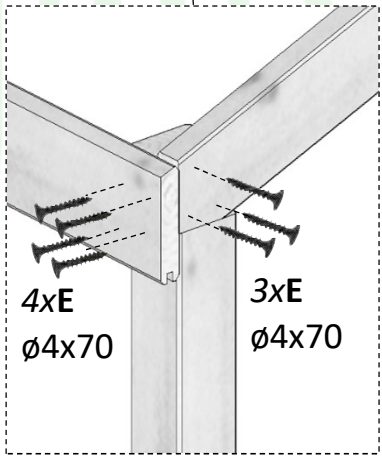

4xE  
 $\phi 4 \times 70$

3xE  
 $\phi 4 \times 70$

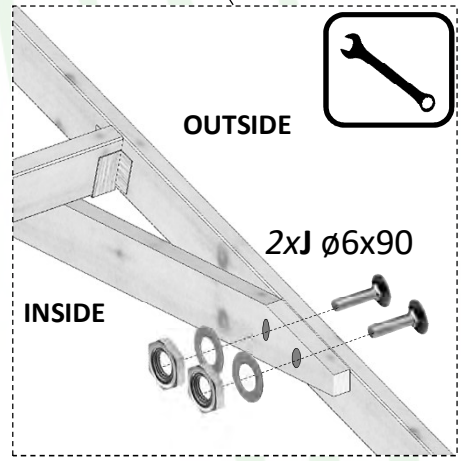

OUTSIDE

2xJ  $\phi 6 \times 90$

INSIDE

5

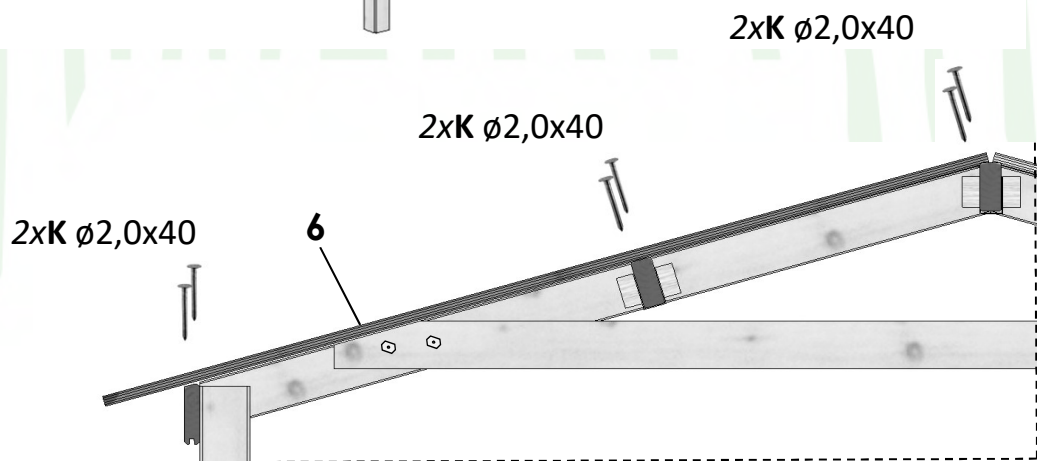
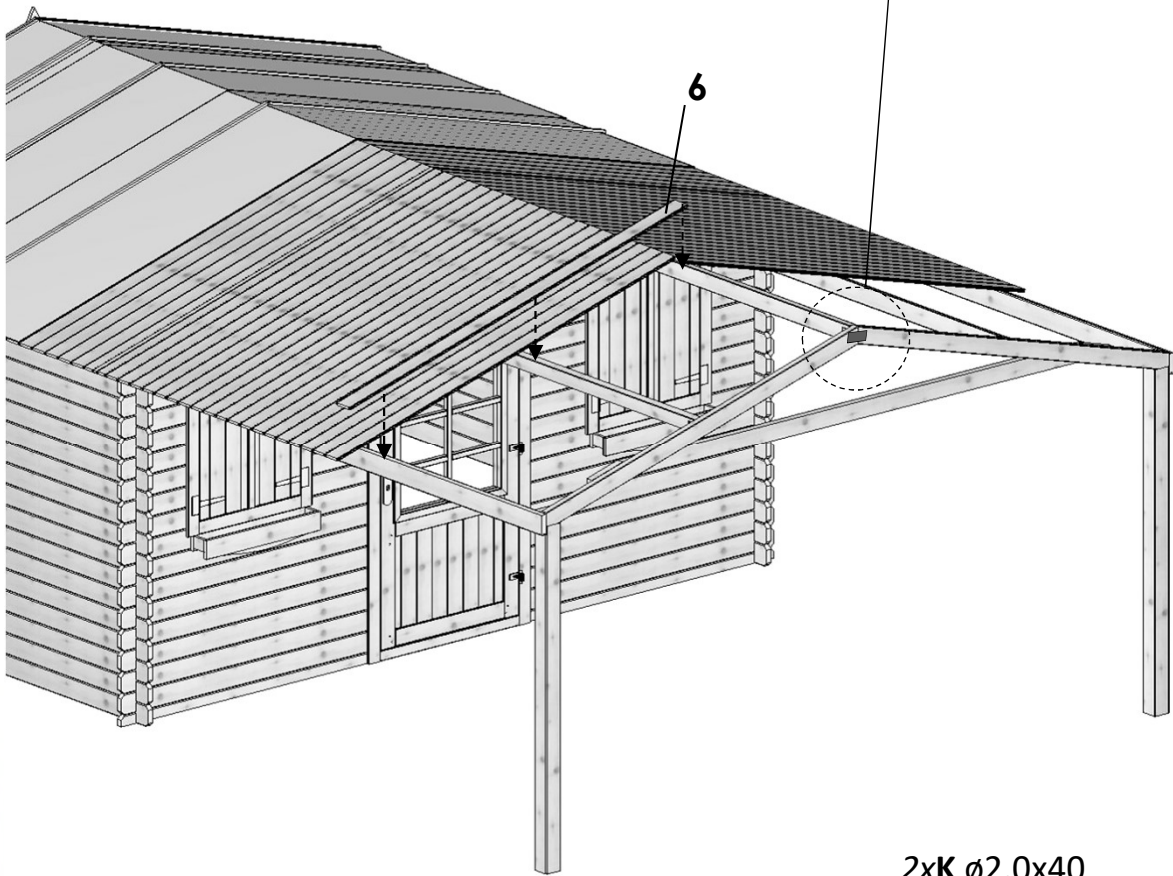
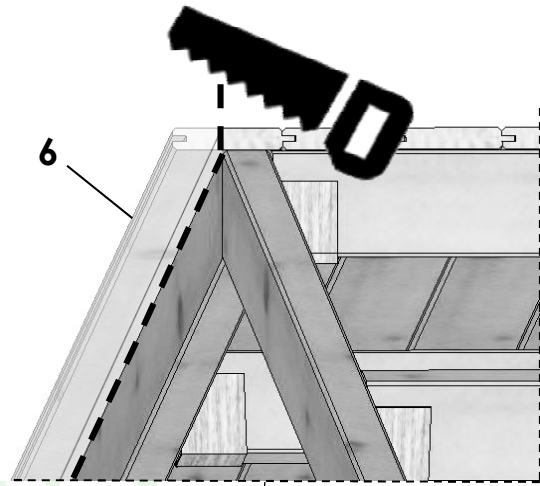

6

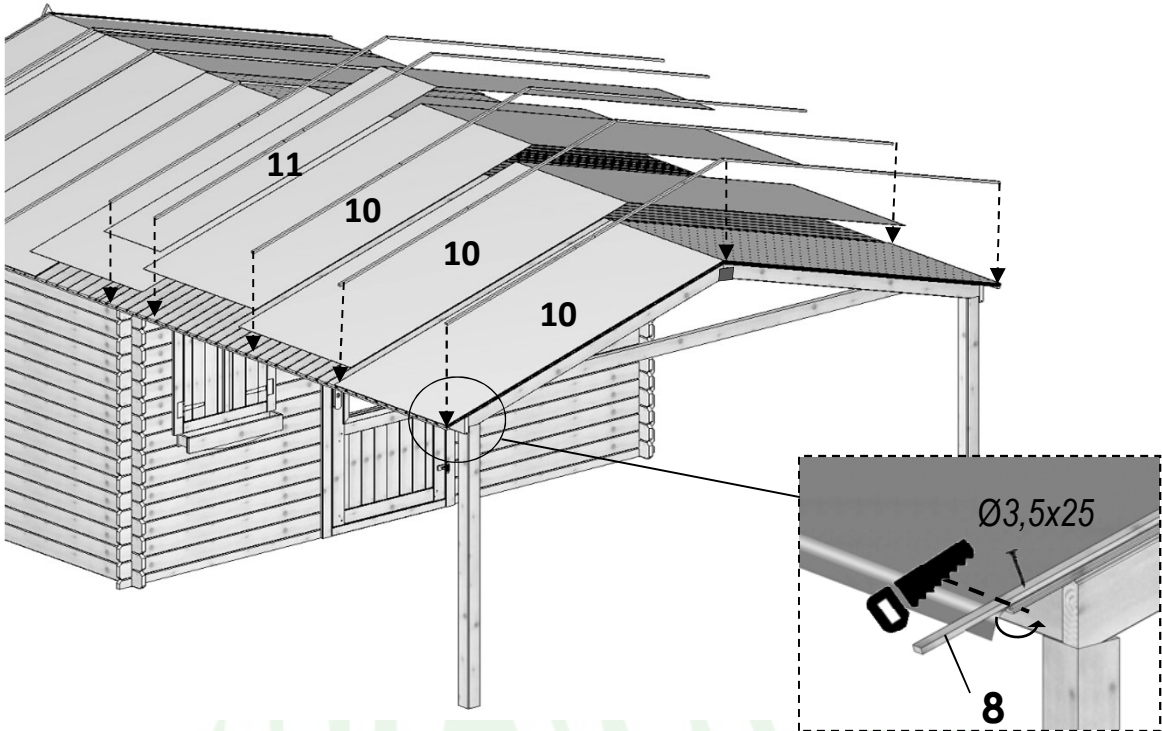
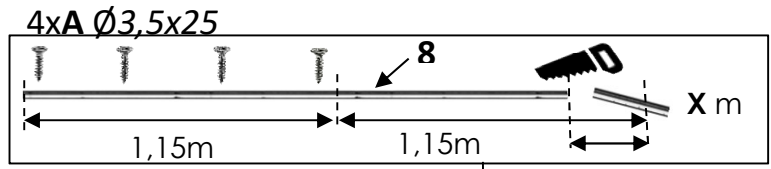



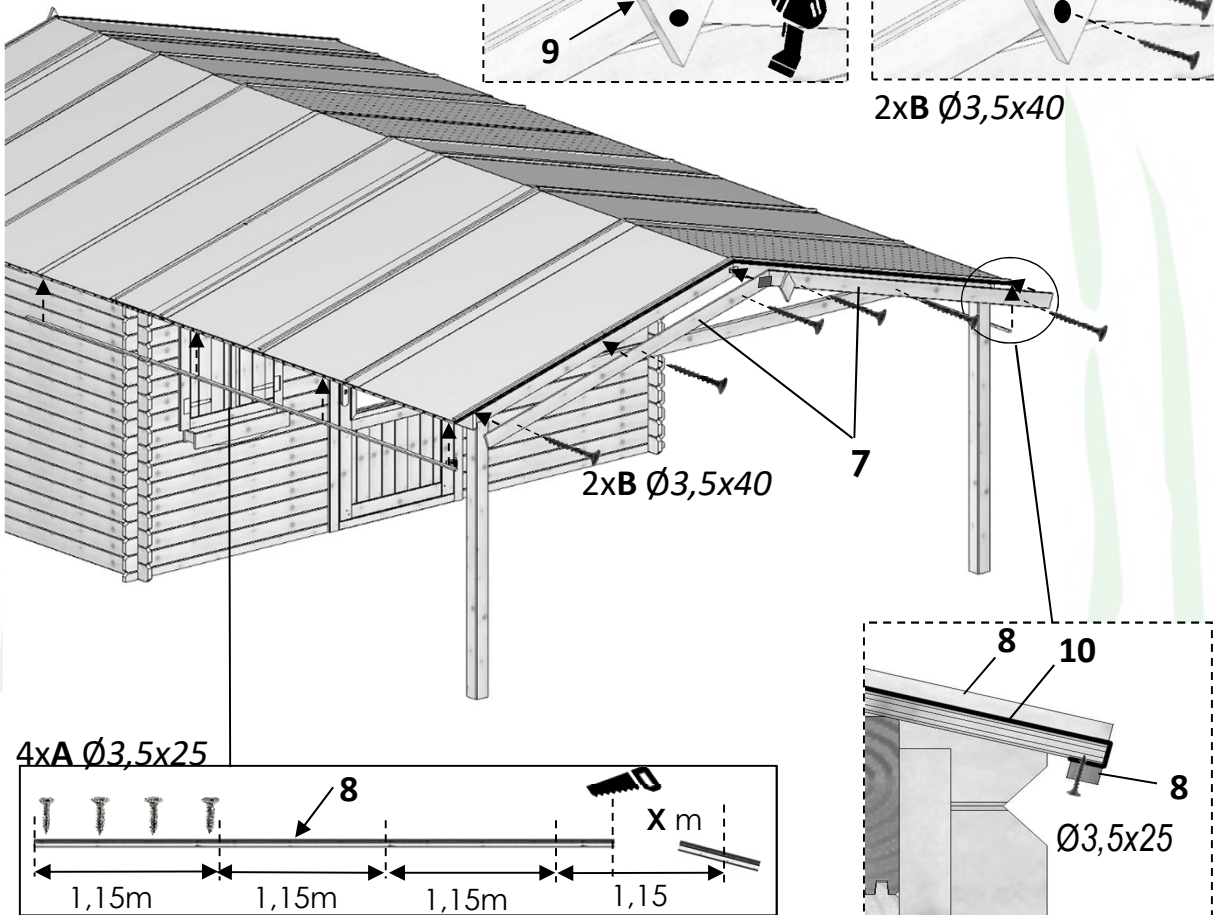
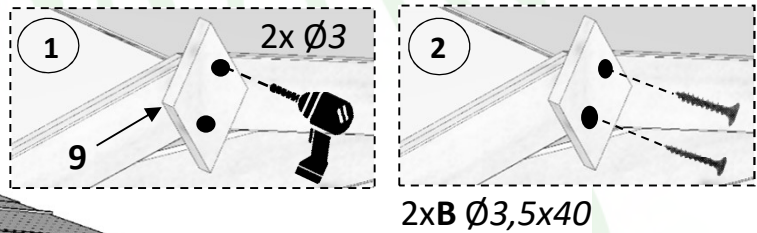

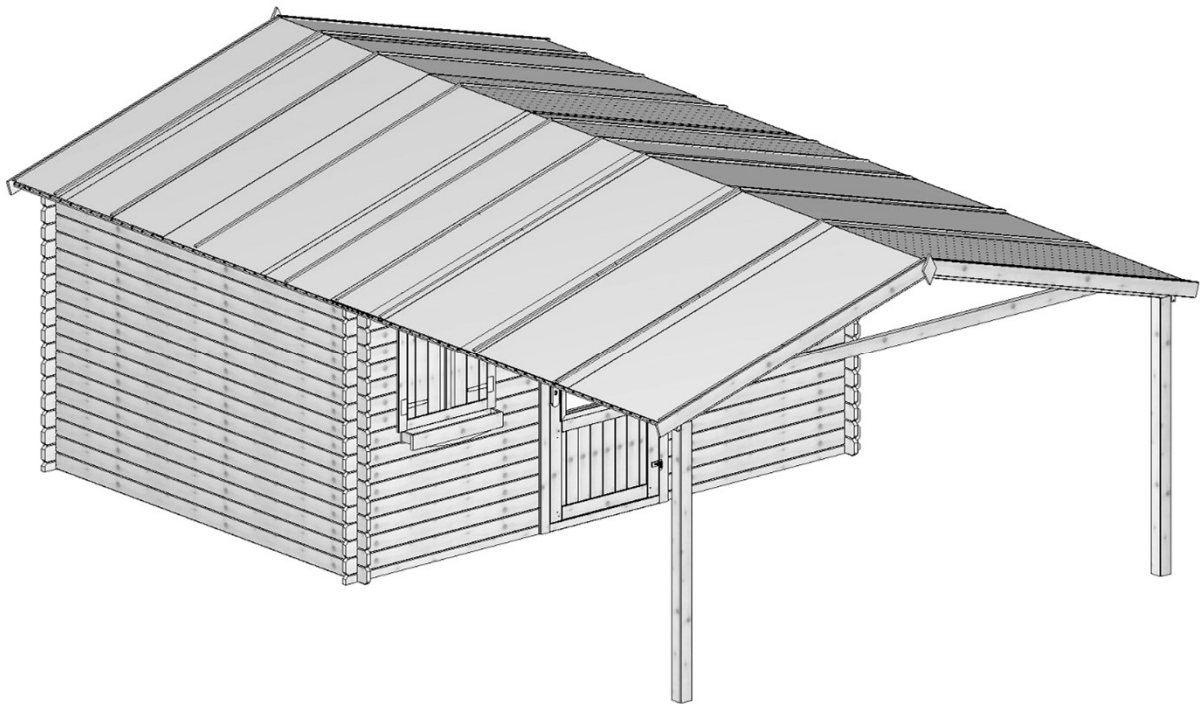













7











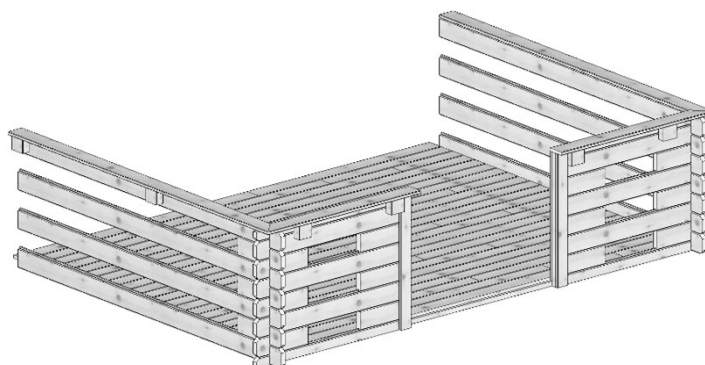











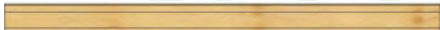

## DOM142-1 300x200cm 28mm

nr.	element	[mm]	[mm]	[mm]	szt.	A	B
1		28	121	2118	<b>6</b>		
2		28	64	1000	<b>2</b>		
3		28	121	350	<b>12</b>		
4		28	121	300	<b>6</b>		
5		28	121	1000	<b>6</b>		
6		28	57	1000	<b>2</b>		
7		28	113	2118	<b>2</b>		
8		19	95	2097	<b>2</b>		
9		19	95	1030	<b>2</b>		
10		67   61	70	790	<b>2</b>		
11		38   45	90	90	<b>8</b>		
12		16	40	986	<b>1</b>		
13		28	58	2400	<b>10</b>		
14		19	99	2400	<b>28</b>		
A		3,5 x 50			<b>52</b>		
B		3,5 x 25			<b>24</b>		
C		2,0 x 40			<b>414</b>		
D					<b>2</b>		







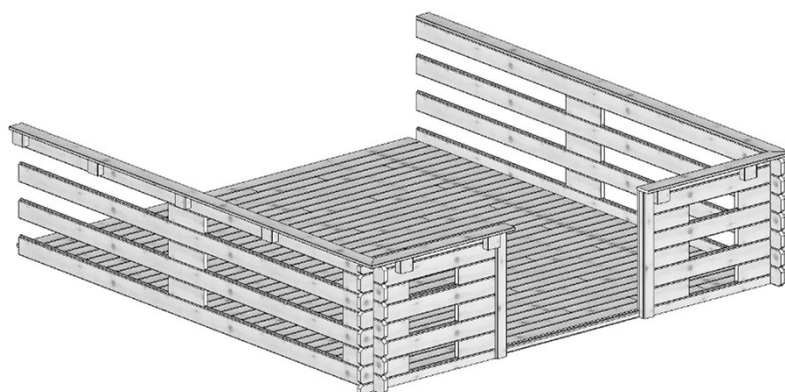









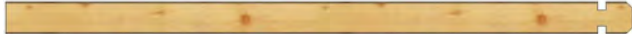



## DOM395-1 300x300cm 28mm

nr.	element	[mm]	[mm]	[mm]	szt.	A	B
1		28	121	3118	<b>6</b>		
2		28	64	1000	<b>2</b>		
3		28	121	350	<b>12</b>		
4		28	121	300	<b>12</b>		
5		28	121	1000	<b>6</b>		
6		28	57	1000	<b>2</b>		
7		28	113	3118	<b>2</b>		
8		19	95	3097	<b>2</b>		
9		19	95	1030	<b>2</b>		
10		67   61	70	790	<b>2</b>		
11		38   45	90	90	<b>12</b>		
12		16	40	986	<b>1</b>		
13		28	58	2400	<b>12</b>		
14		19	99	2400	<b>42</b>		
A		3,5 x 50			<b>68</b>		
B		3,5 x 25			<b>24</b>		
C		2,0 x 41			<b>612</b>		
D					<b>2</b>		







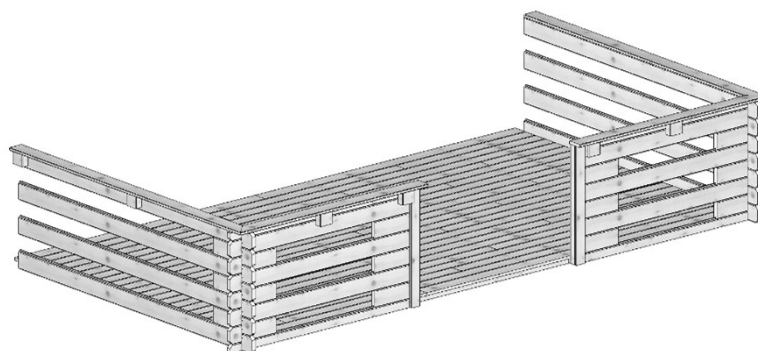













## DOM18-1 400x200cm 28mm

nr.	element	[mm]	[mm]	[mm]	szt.	A	B
1		28	121	2118	<b>6</b>		
2		28	64	1400	<b>2</b>		
3		28	121	350	<b>12</b>		
4		28	121	300	<b>6</b>		
5		28	121	1400	<b>6</b>		
6		28	57	1400	<b>2</b>		
7		28	113	2118	<b>2</b>		
8		19	95	2097	<b>2</b>		
9		19	95	1430	<b>2</b>		
10		67   61	70	790	<b>2</b>		
11		38   45	90	90	<b>8</b>		
12		16	40	1186	<b>1</b>		
13		28	58	2400	<b>16</b>		
14		19	99	2400	<b>39</b>		
A		3,5 x 50			<b>52</b>		
B		3,5 x 25			<b>24</b>		
C		2,0 x 40			<b>616</b>		
D		60 x 60 x 40			<b>2</b>		



## DOM393-1 400x300cm 28mm

nr.	element	[mm]	[mm]	[mm]	szt.	A	B
1		28	121	3118	<b>6</b>		
2		28	64	1400	<b>2</b>		
3		28	121	350	<b>12</b>		
4		28	121	300	<b>12</b>		
5		28	121	1400	<b>6</b>		
6		28	57	1400	<b>2</b>		
7		28	113	3118	<b>2</b>		
8		19	95	3097	<b>2</b>		
9		19	95	1430	<b>2</b>		
10		67   61	70	790	<b>2</b>		
11		38   45	90	90	<b>12</b>		
12		16	40	1186	<b>1</b>		
13		28	58	2400	<b>18</b>		
14		19	99	2400	<b>56</b>		
A		3,5 x 50			<b>68</b>		
B		3,5 x 25			<b>24</b>		
C		2,0 x 41			<b>912</b>		
D		60 x 60 x 40			<b>2</b>		

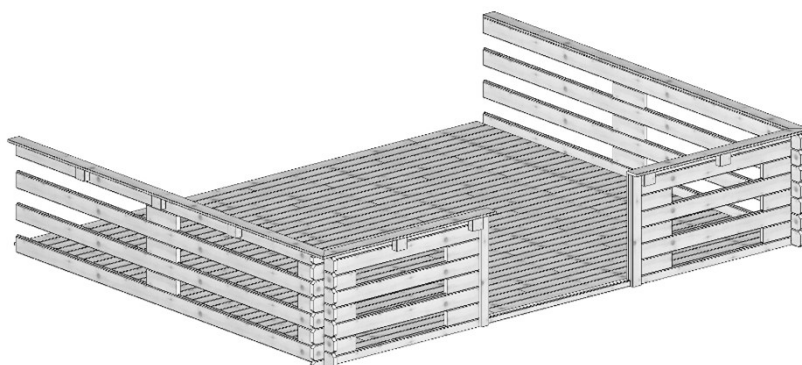

DOM142-1 DOM395-1 DOM18-1 DOM393-1

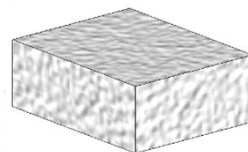
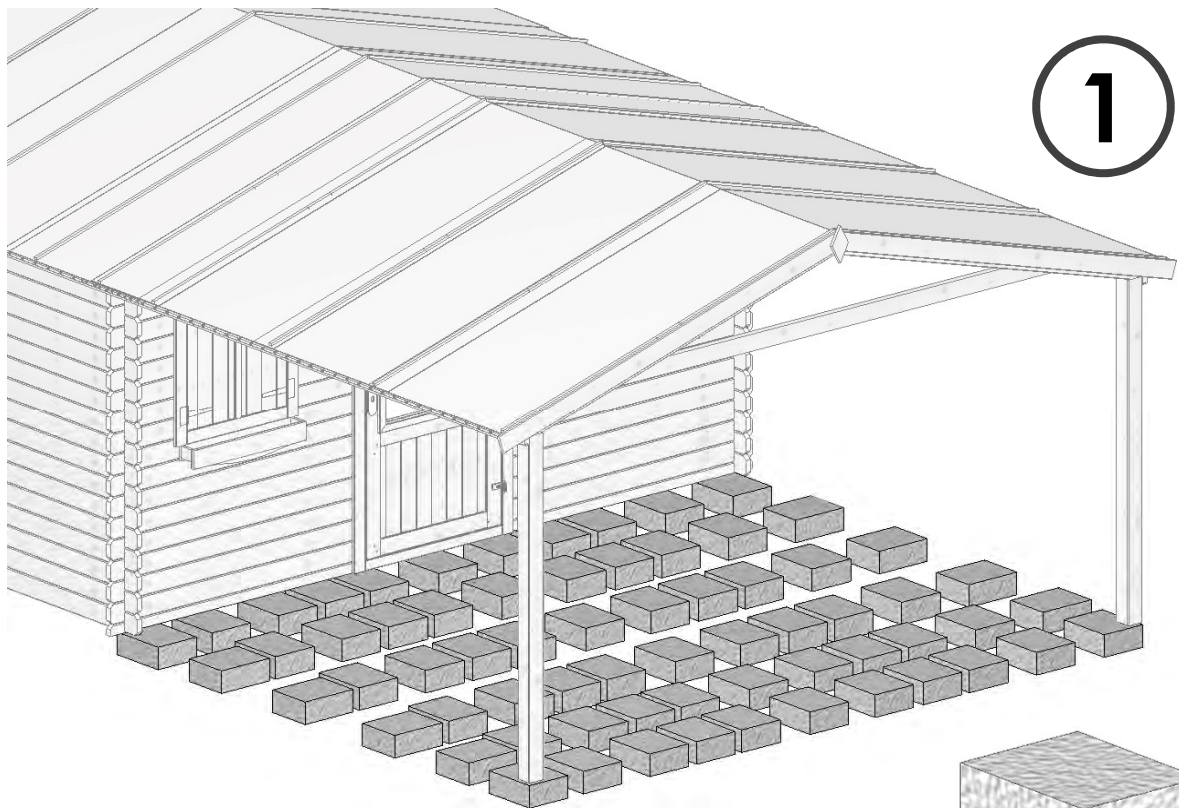

DOM142-1 300x200cm 28mm

32x 300x240x120

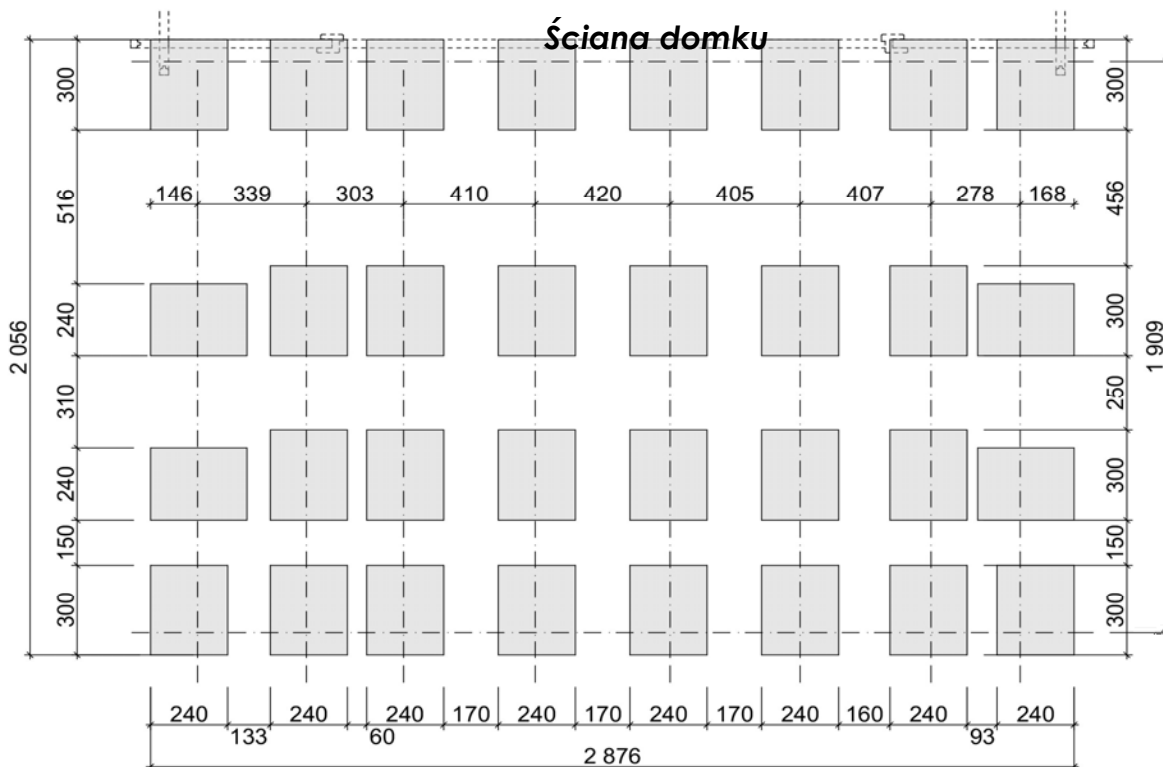

# DOM 395-1 300x300cm 28mm

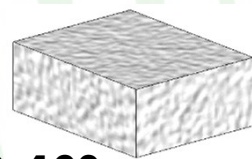
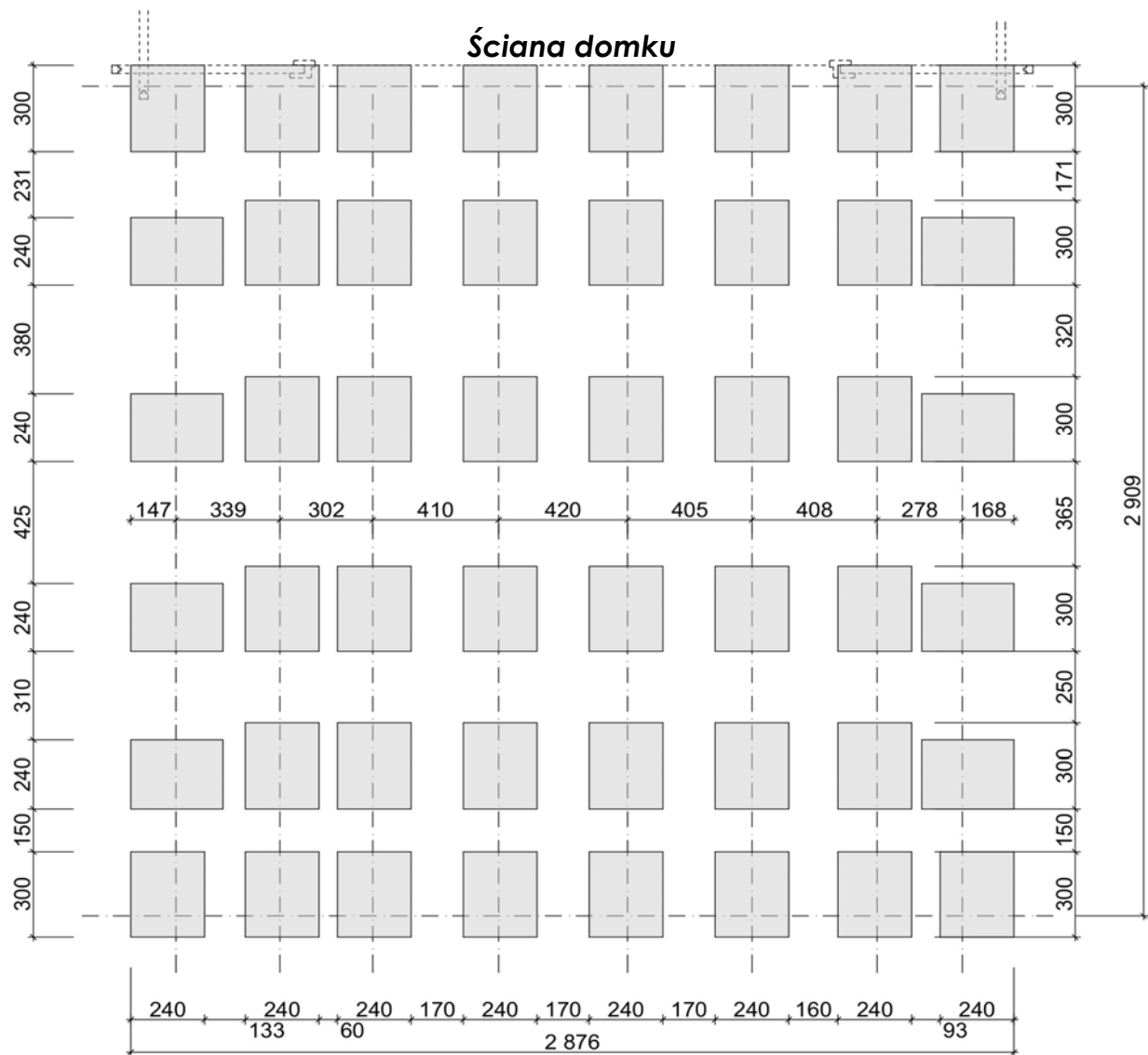

**48x 300x240x120**

# DOM18-1 400x200cm 28mm

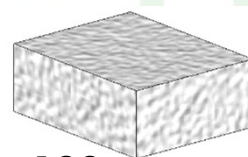
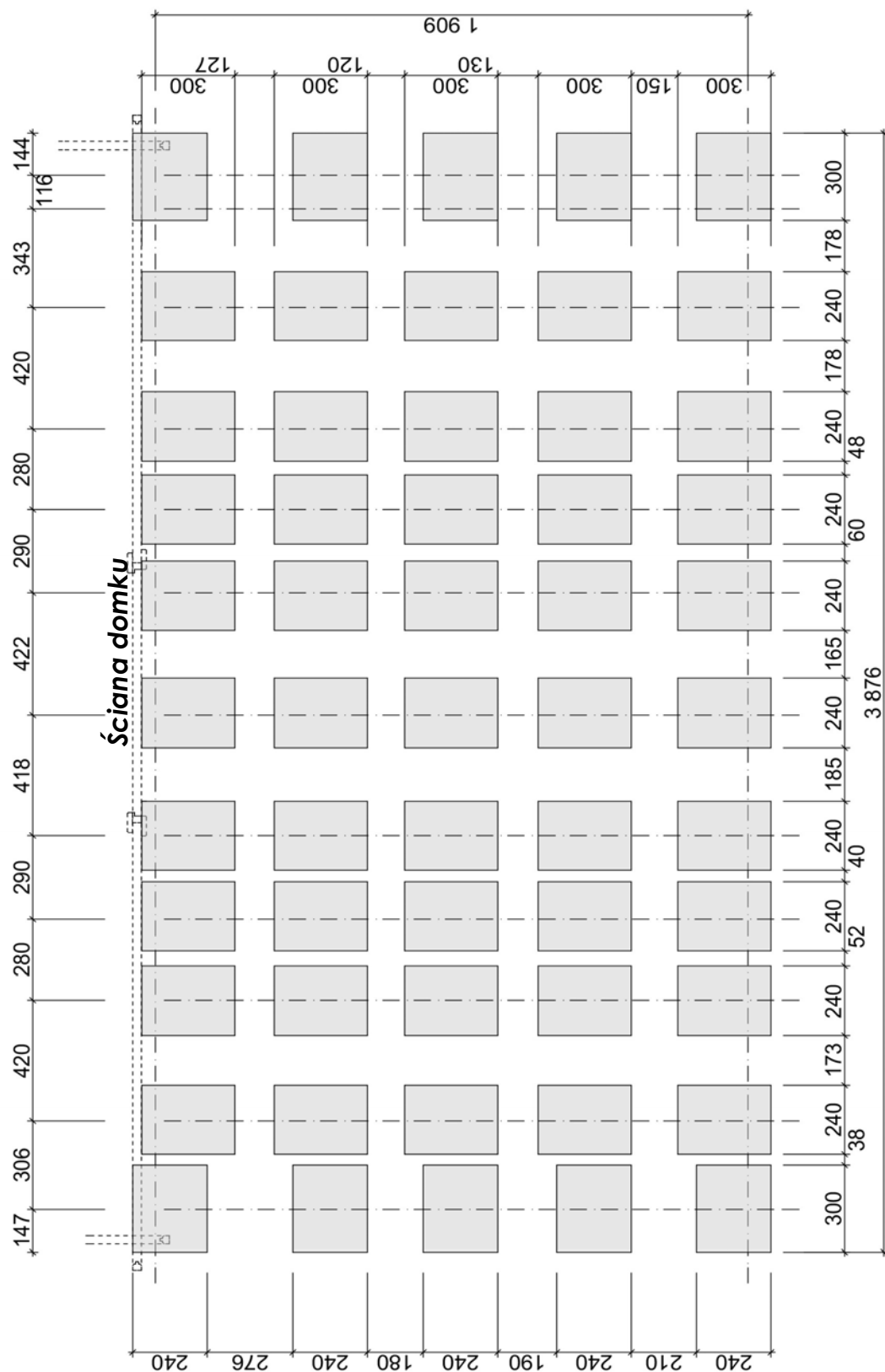

55x **300x240x120**



2xA Ø3,5x50

2

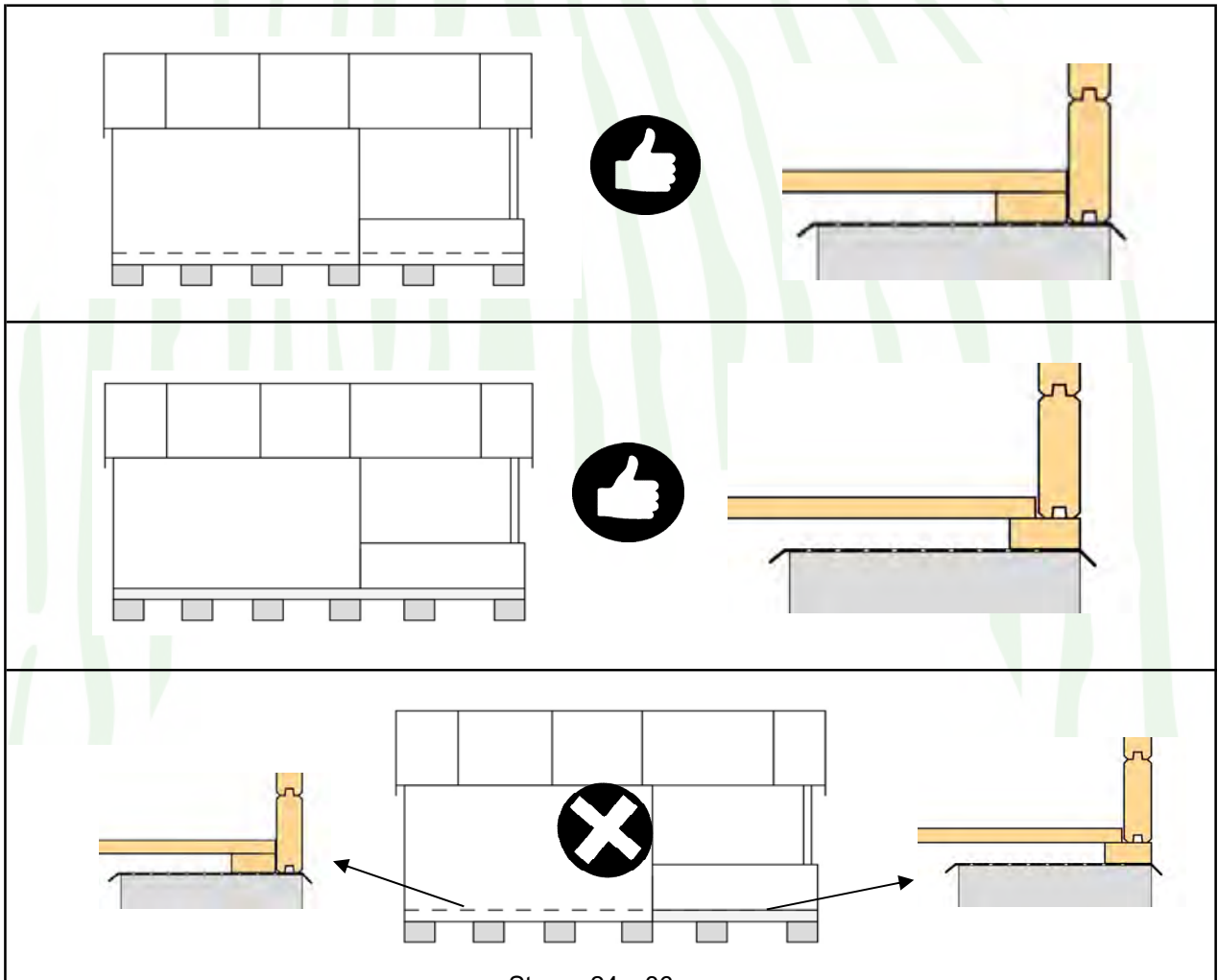
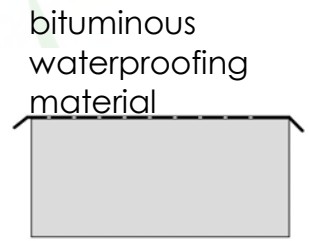
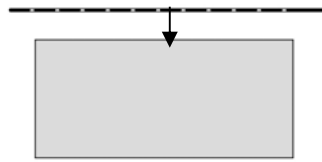
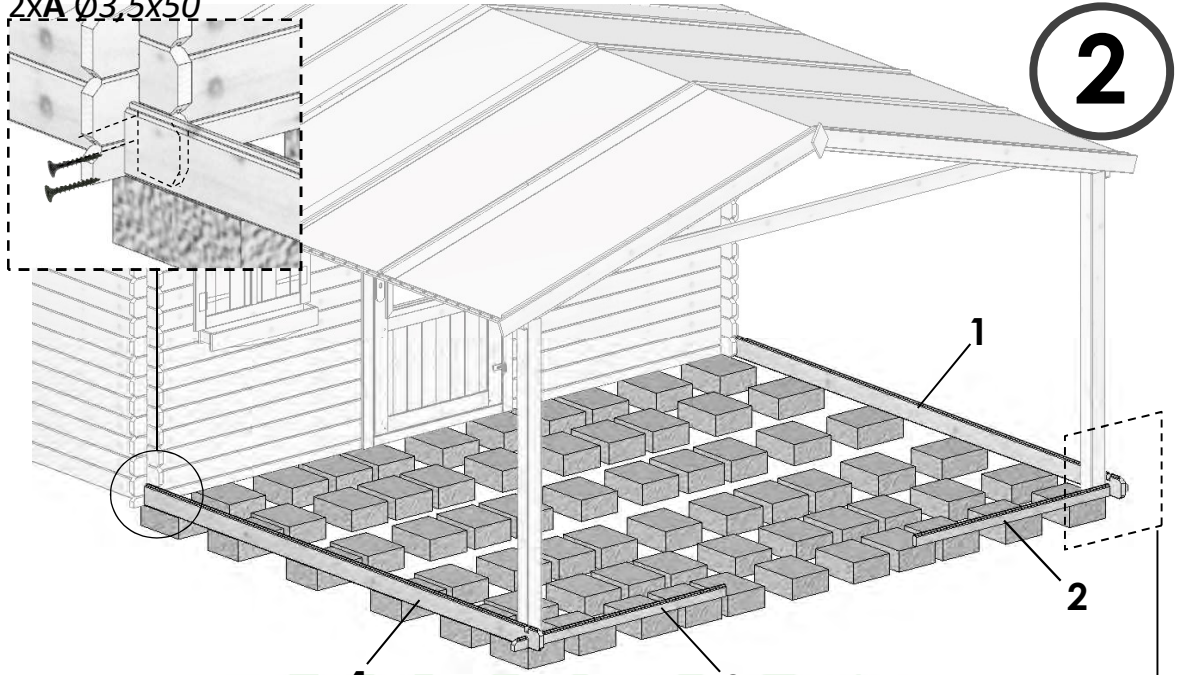

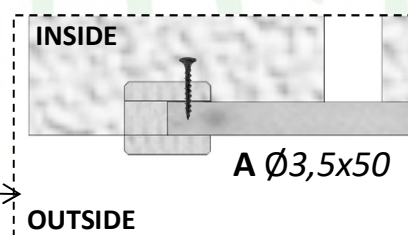
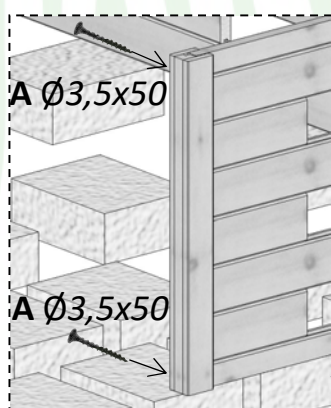
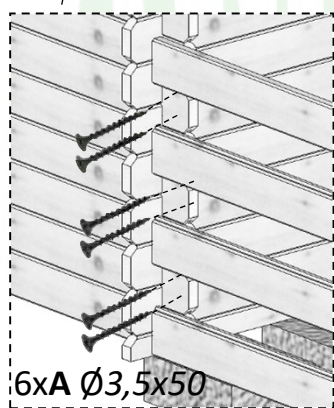
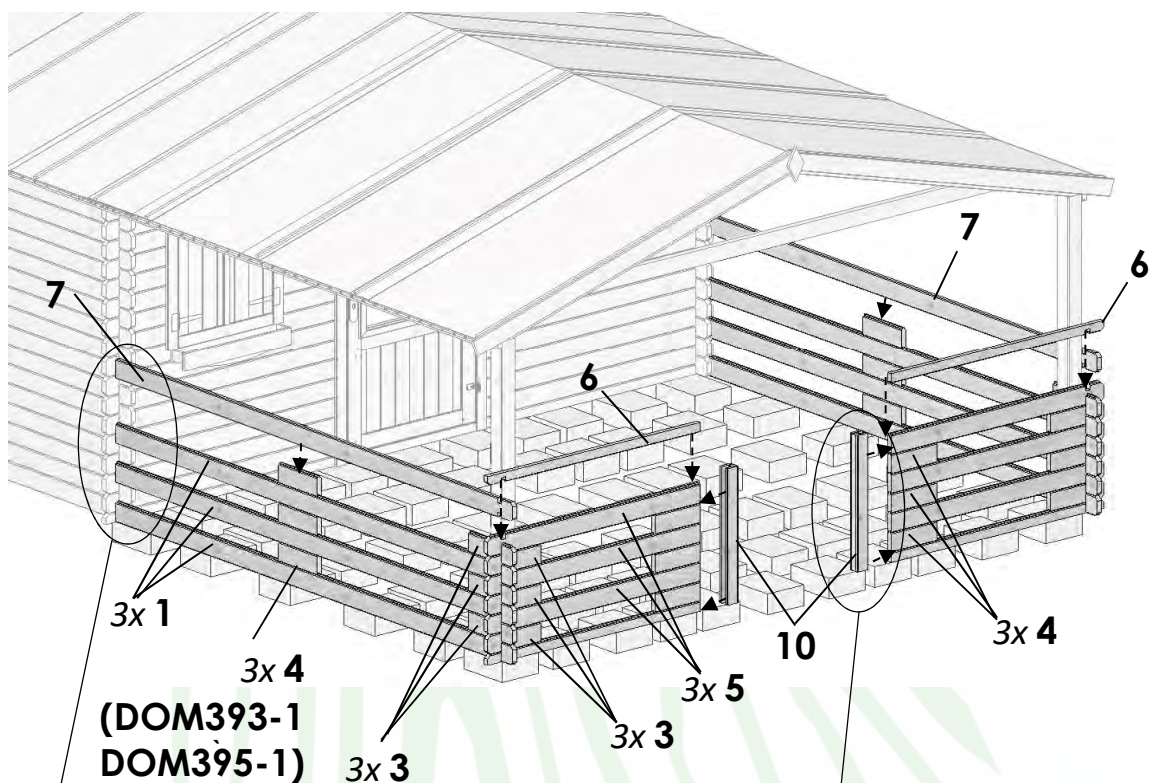

4

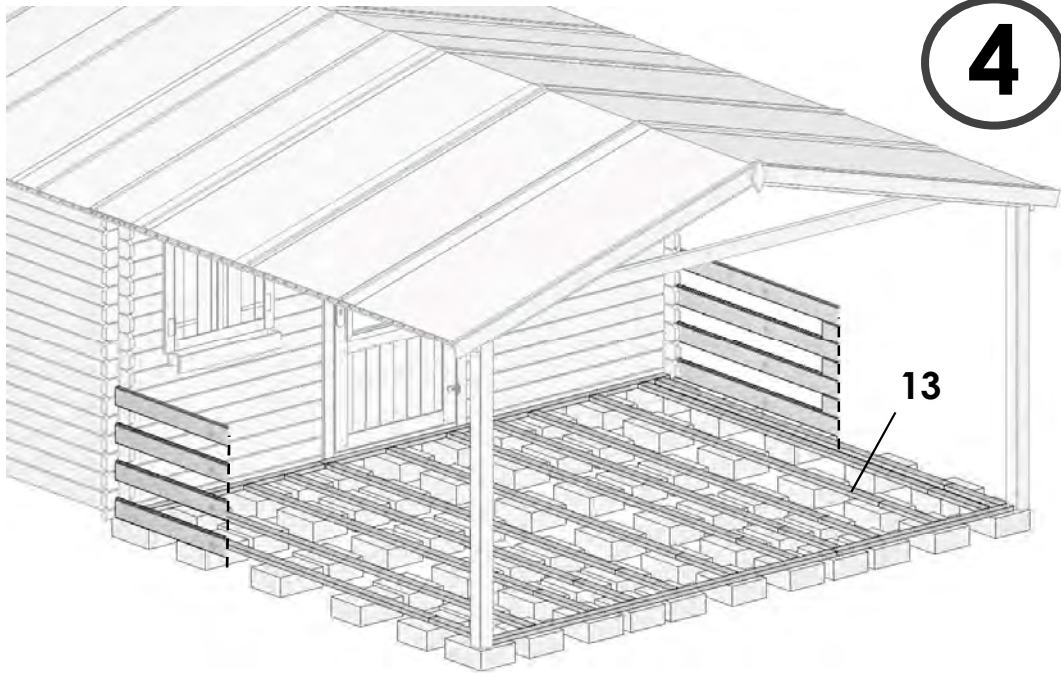

DOM142-1 300x200cm 28mm

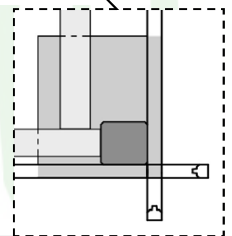
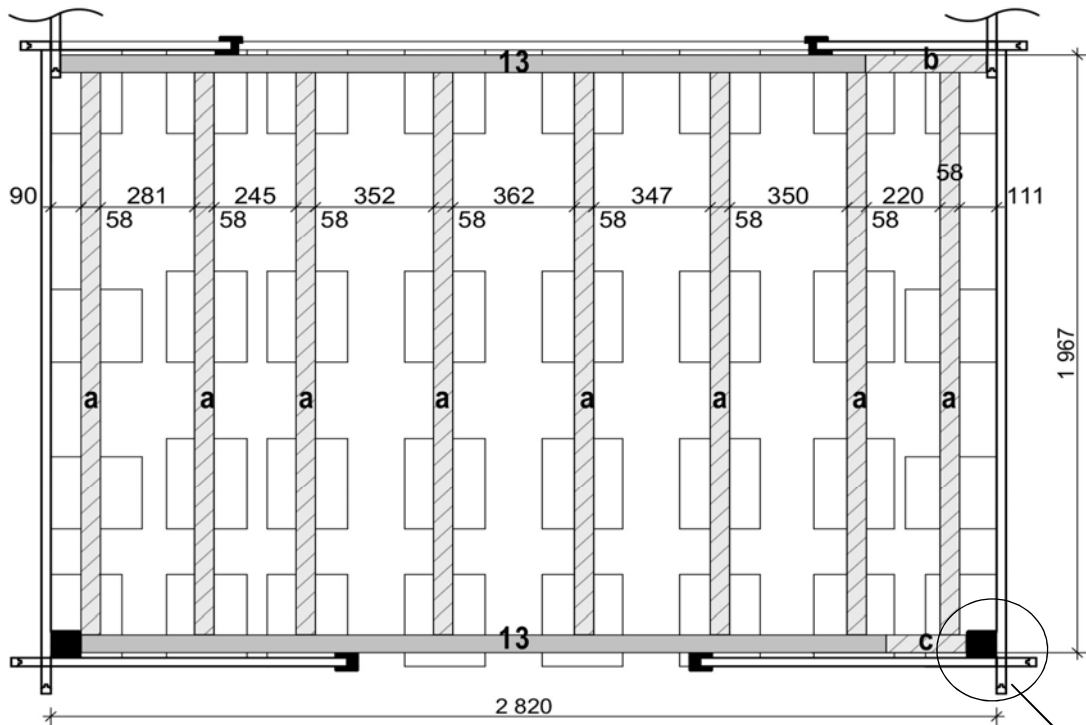

- 2x **13** Legar 28x58x2400 mm 2400
- 8x **a** Legar 28x58x1850 mm 1850
- 1x **b** Legar 28x58x360 mm 360 190
- 1x **c** Legar 28x58x238 mm 1850 238 312

# DOM395-1 300x300cm 28mm

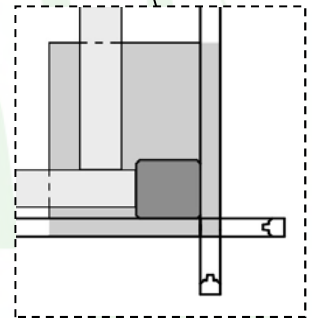
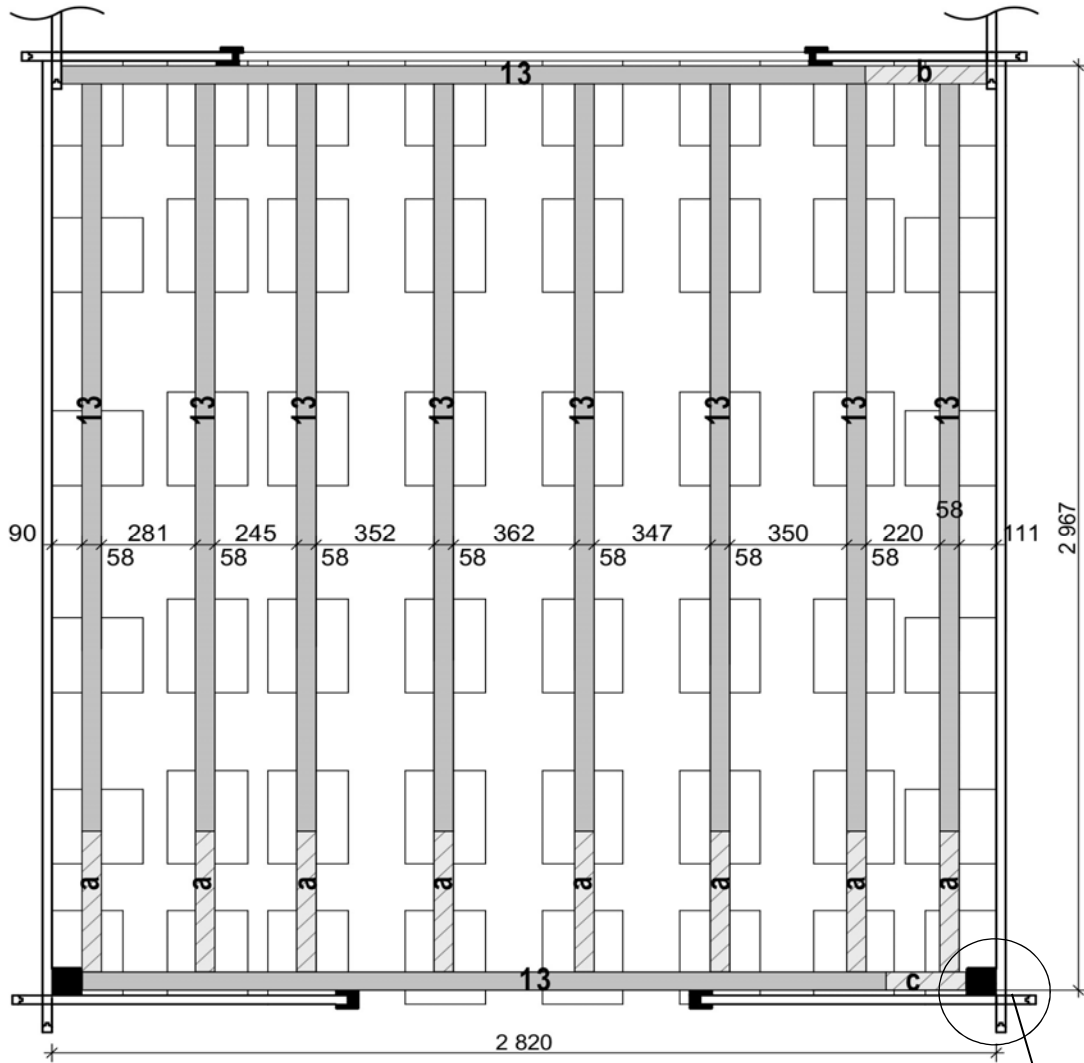

10x **13** Legar 28x58x2400 mm

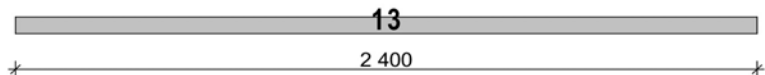

8x **a** Legar 28x58x450 mm

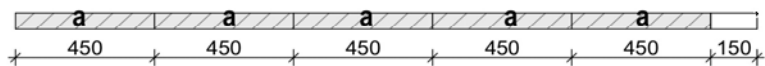

1x **b** Legar 28x58x362 mm

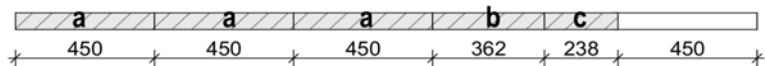

1x **c** Legar 28x58x238 mm

# DOM18-1 400x200cm 28mm

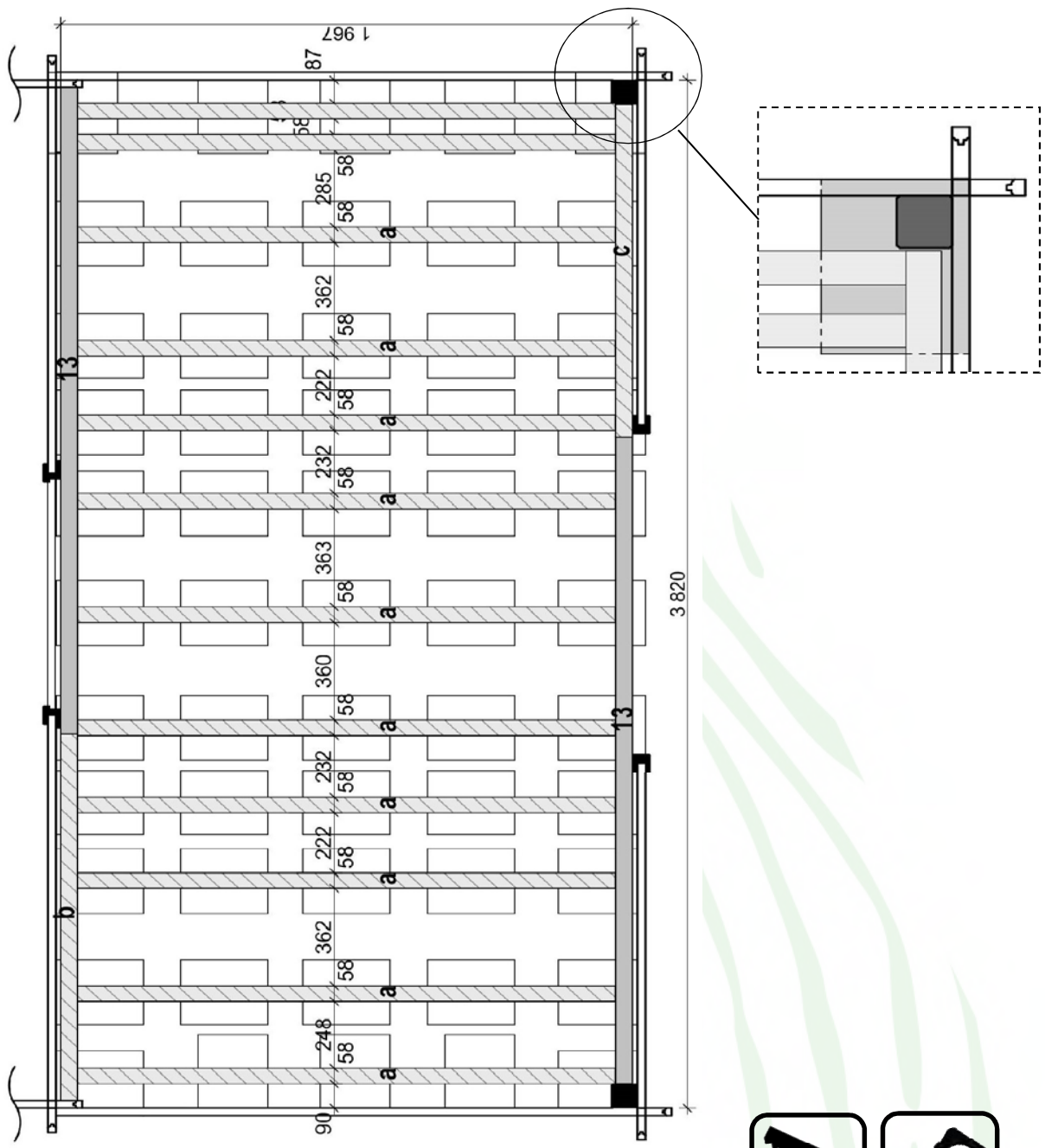

- 2x **13** Legar 28x58x**2400** mm
- 12x **a** Legar 28x58x**1850** mm
- 1x **b** Legar 28x58x**1360** mm
- 1x **c** Legar 28x58x**1238** mm

# DOM393-1 400x300cm 28mm

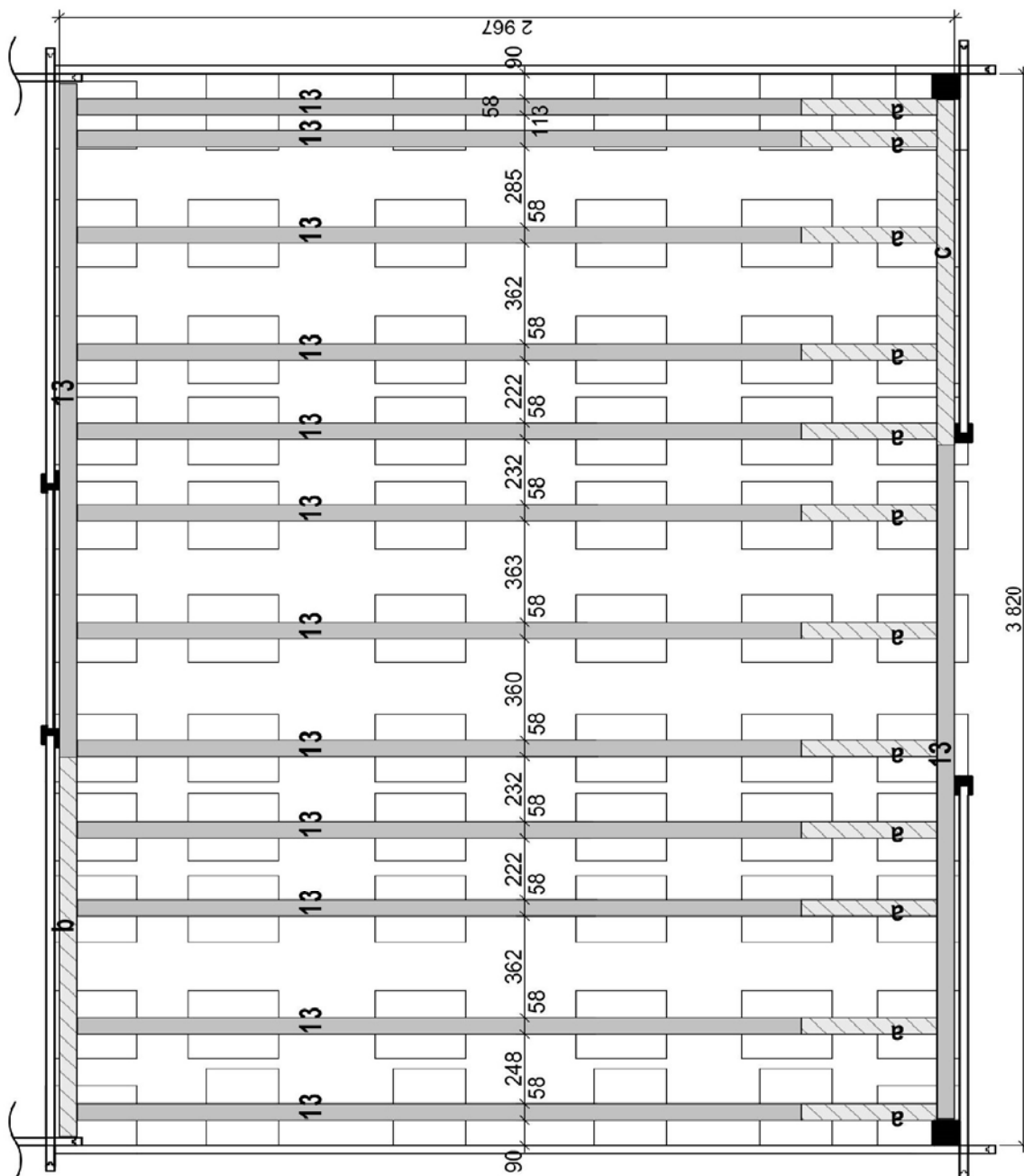

14x **13** Legar 28x58x2400 mm

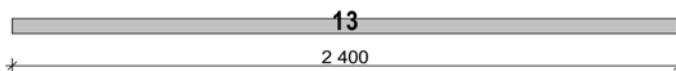

12x **a** Legar 28x58x450 mm

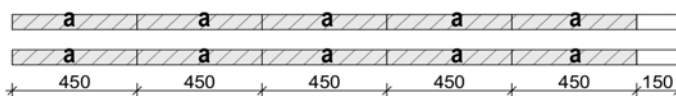

1x **b** Legar 28x58x1350 mm

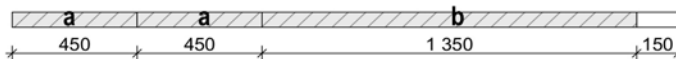

1x **c** Legar 28x58x1230 mm

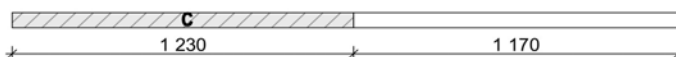

5

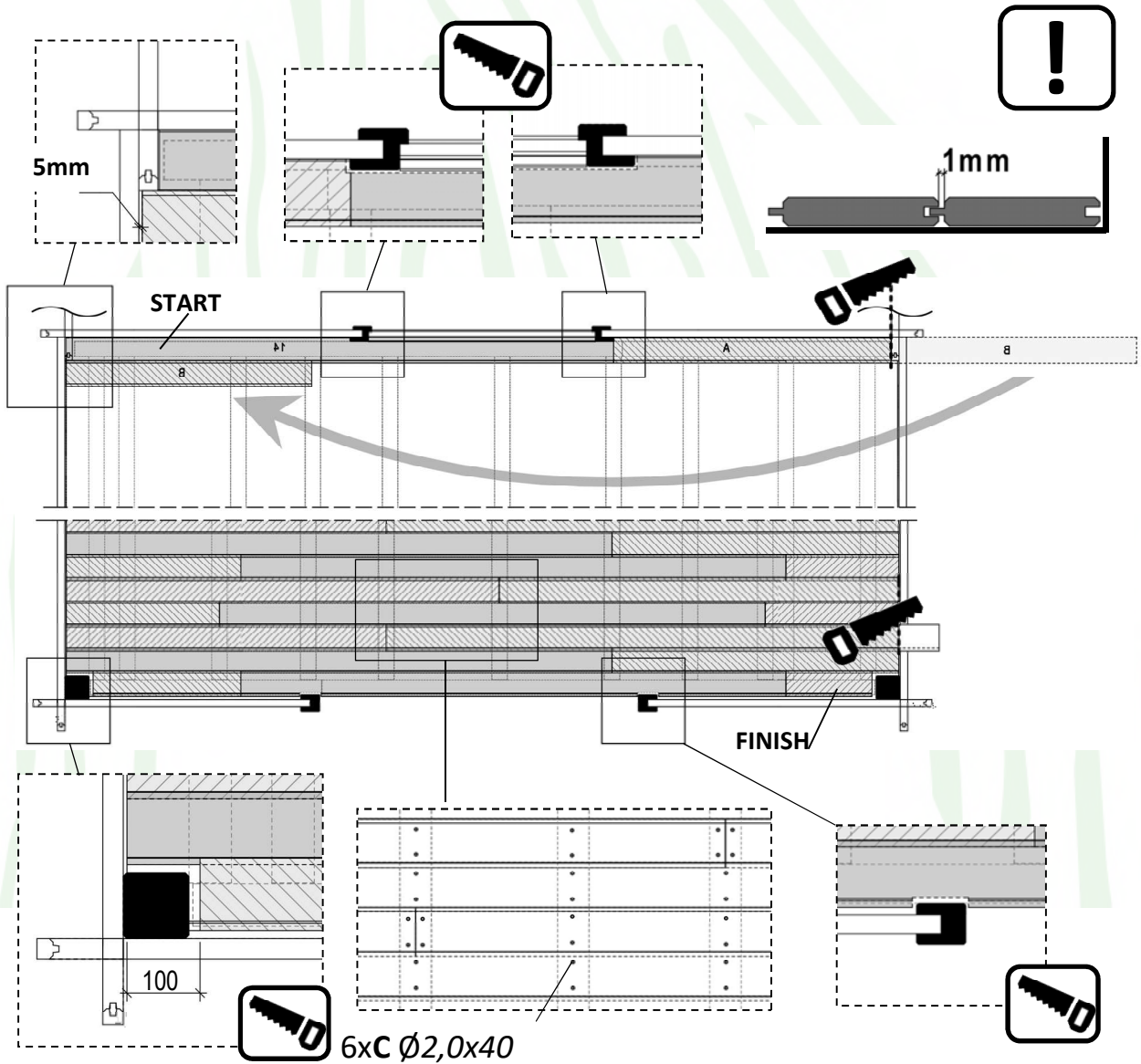
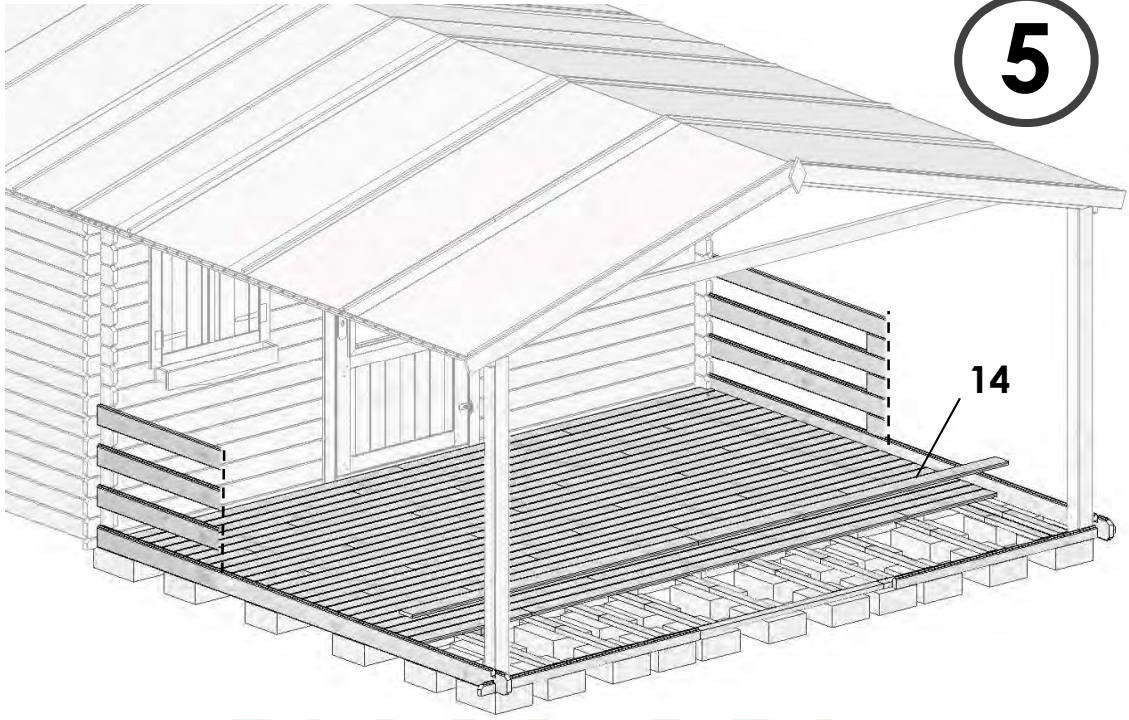

# DOM142-1 300x200cm 28mm

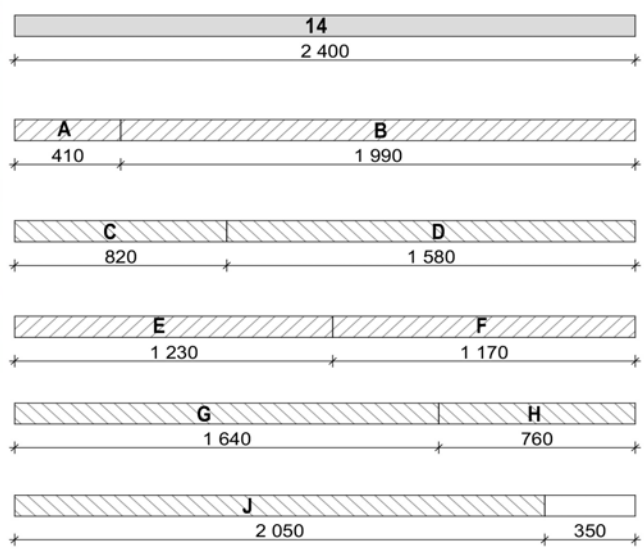
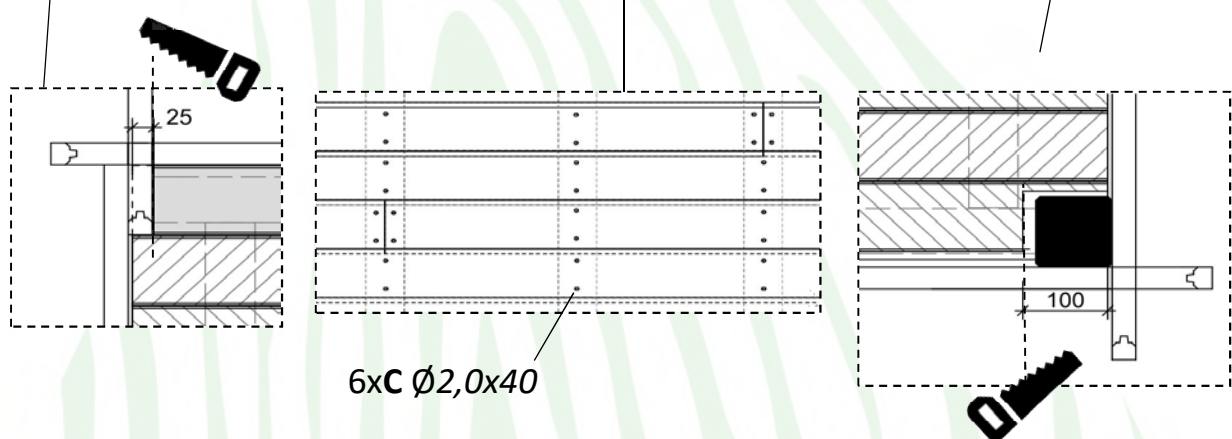
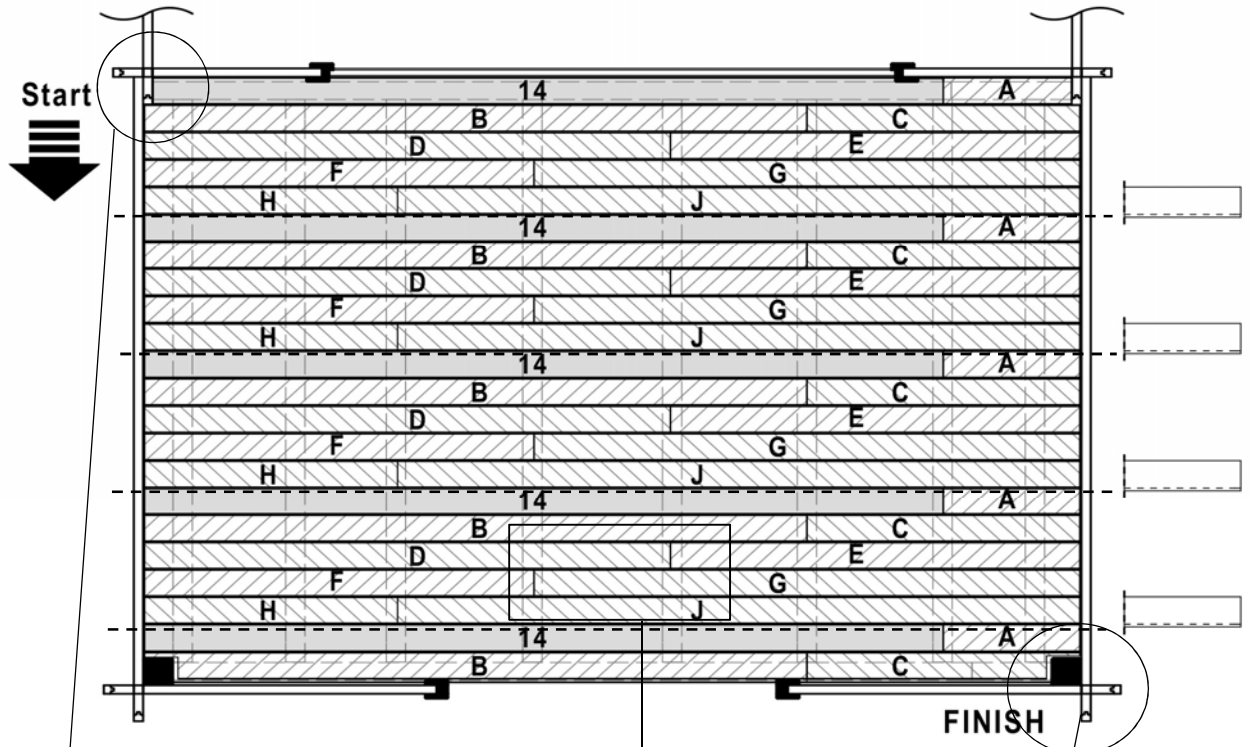

- 5x 14 Deska podłogi 19x99x2400 mm
- 5x **A** 19x99x410 mm
- 5x **B** 19x99x1990 mm
- 5x **C** 19x99x820 mm
- 4x **D** 19x99x1580 mm
- 4x **E** 19x99x1230 mm
- 4x **F** 19x99x1170 mm
- 4x **G** 19x99x1640 mm
- 4x **H** 19x99x760 mm
- 4x **J** 19x99x2050 mm

# DOM395-1 300x300cm 28mm

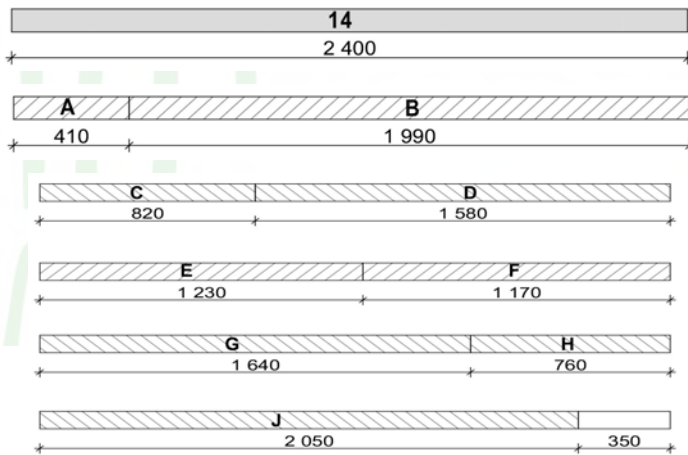
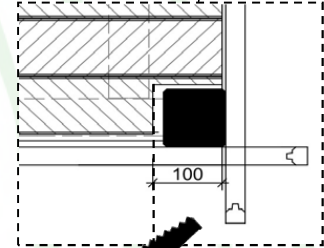
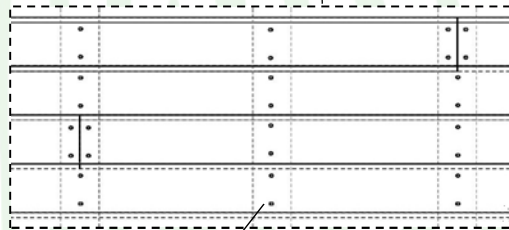
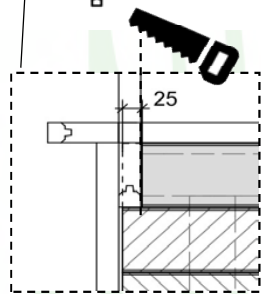
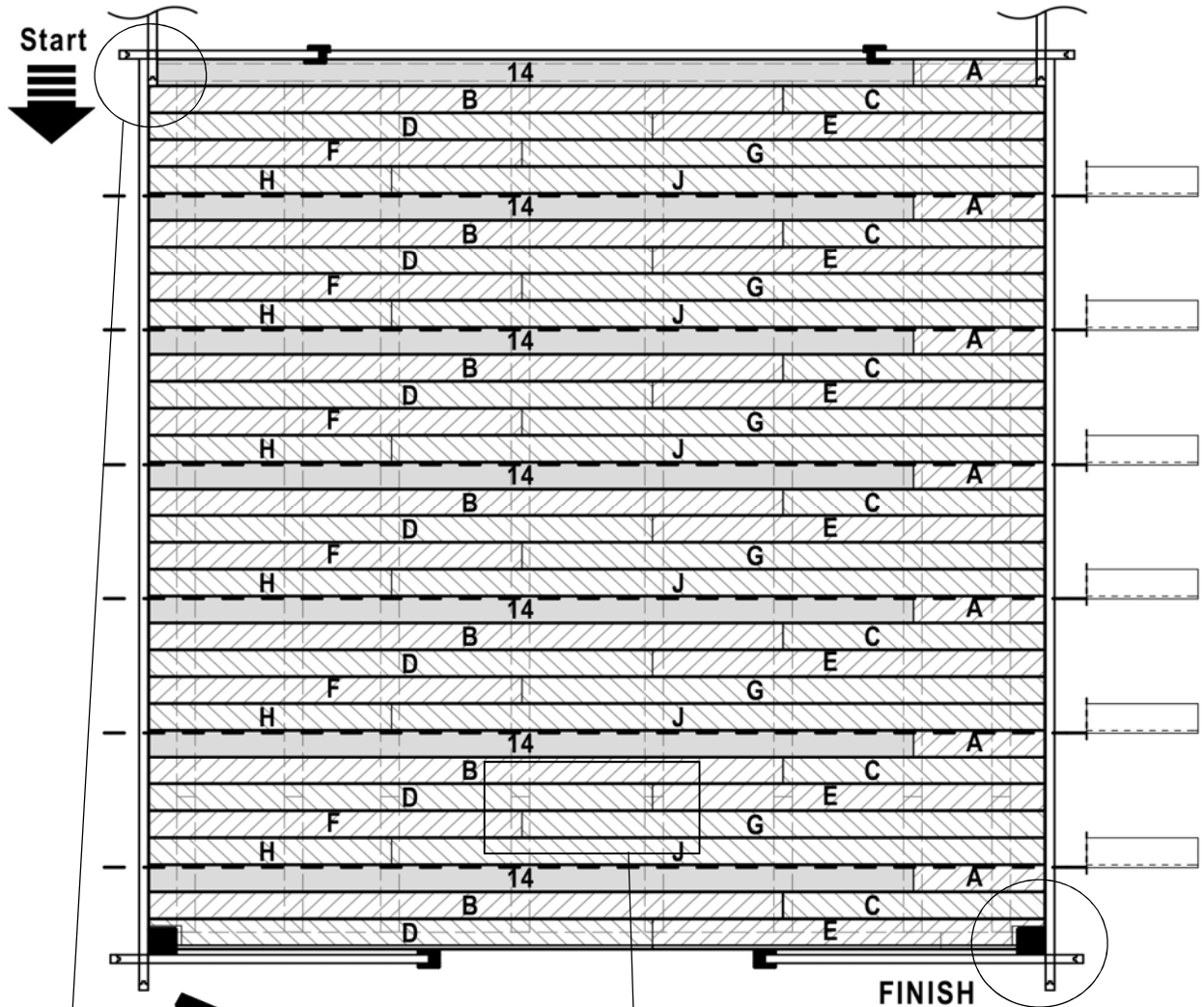

7x **14** Deska podłogi 19x99x2400 mm

7x **A** 19x99x410 mm

7x **B** 19x99x1990 mm

7x **C** 19x99x820 mm

7x **D** 19x99x1580 mm

7x **E** 19x99x1230 mm

6x **F** 19x99x1170 mm

6x **G** 19x99x1640 mm

6x **H** 19x99x760 mm

6x **J** 19x99x2050 mm



# DOM393-1 400x300cm 28mm

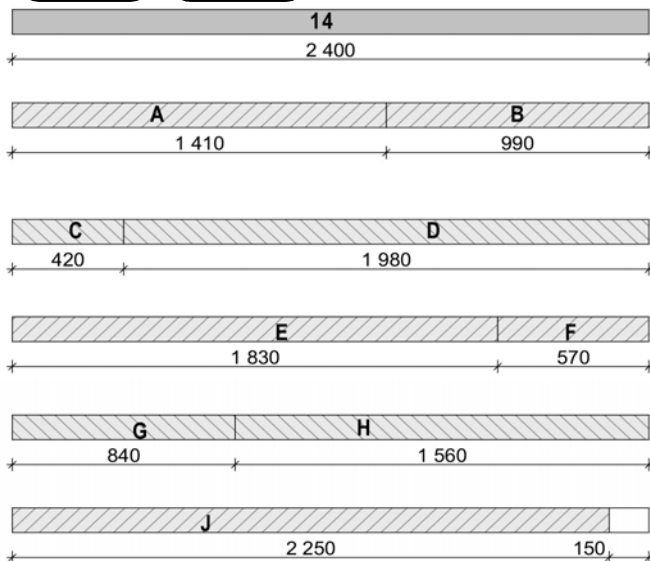
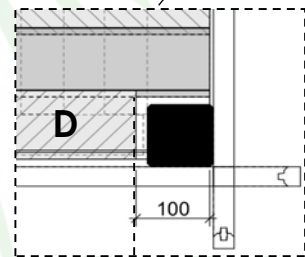
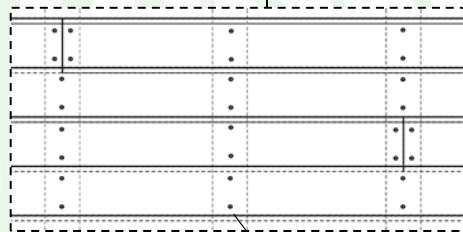
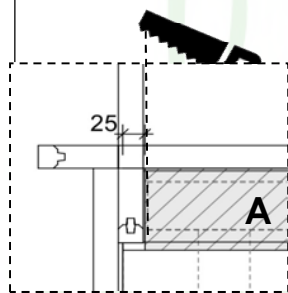
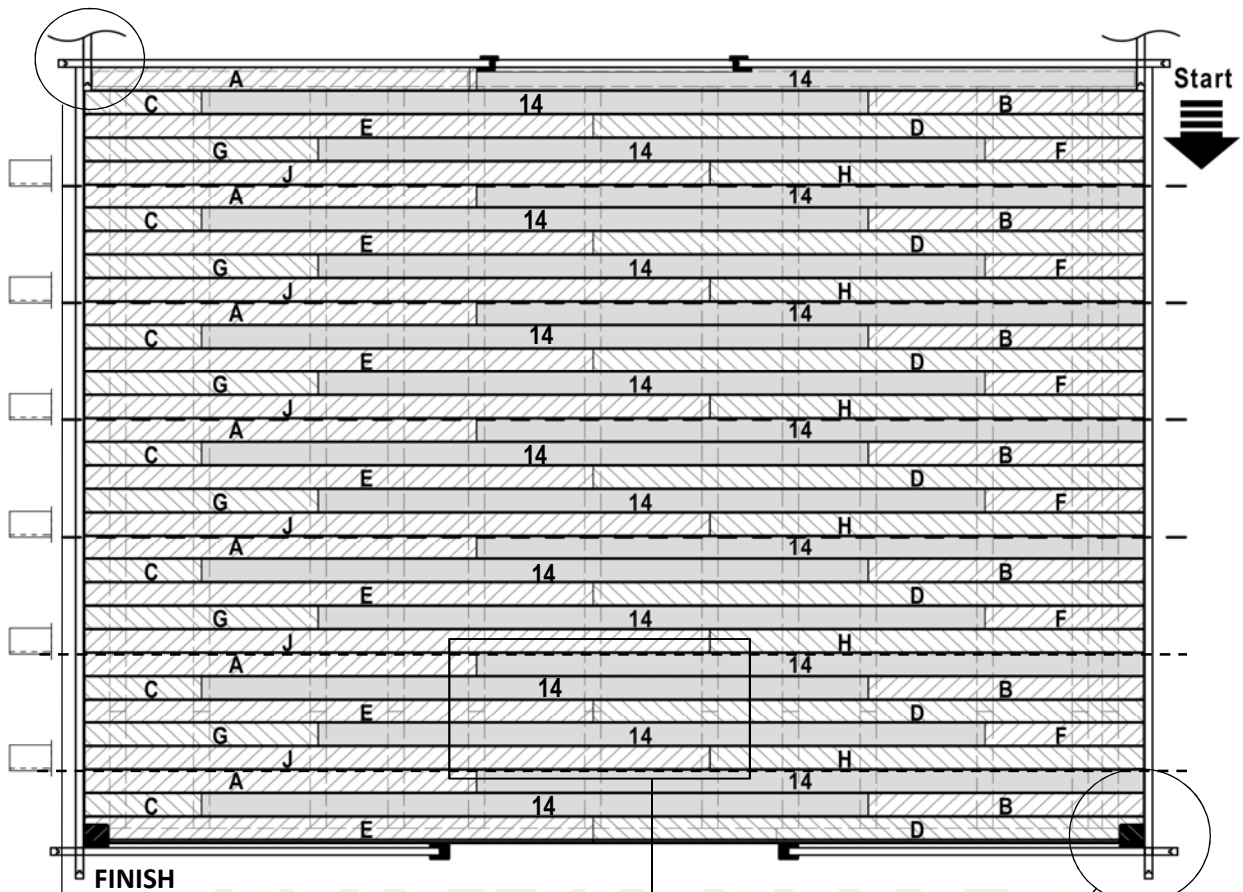

C Ø2,0x40

20x 14 Deska podłogi 19x99x2400 mm

- 7x **A** 19x99x1410 mm
- 7x **B** 19x99x990 mm
- 7x **C** 19x99x420 mm
- 7x **D** 19x99x1980 mm
- 7x **E** 19x99x1830 mm
- 6x **F** 19x99x570 mm
- 6x **G** 19x99x840 mm
- 6x **H** 19x99x1560 mm
- 6x **J** 19x99x2250 mm

6

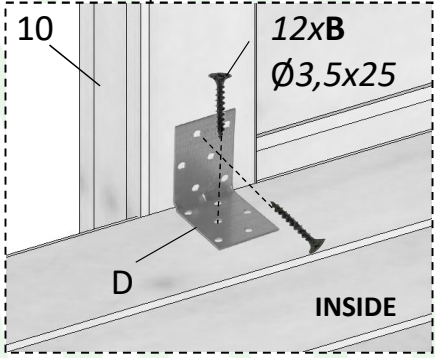
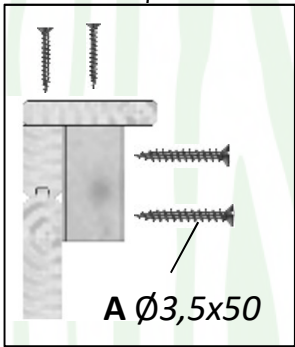
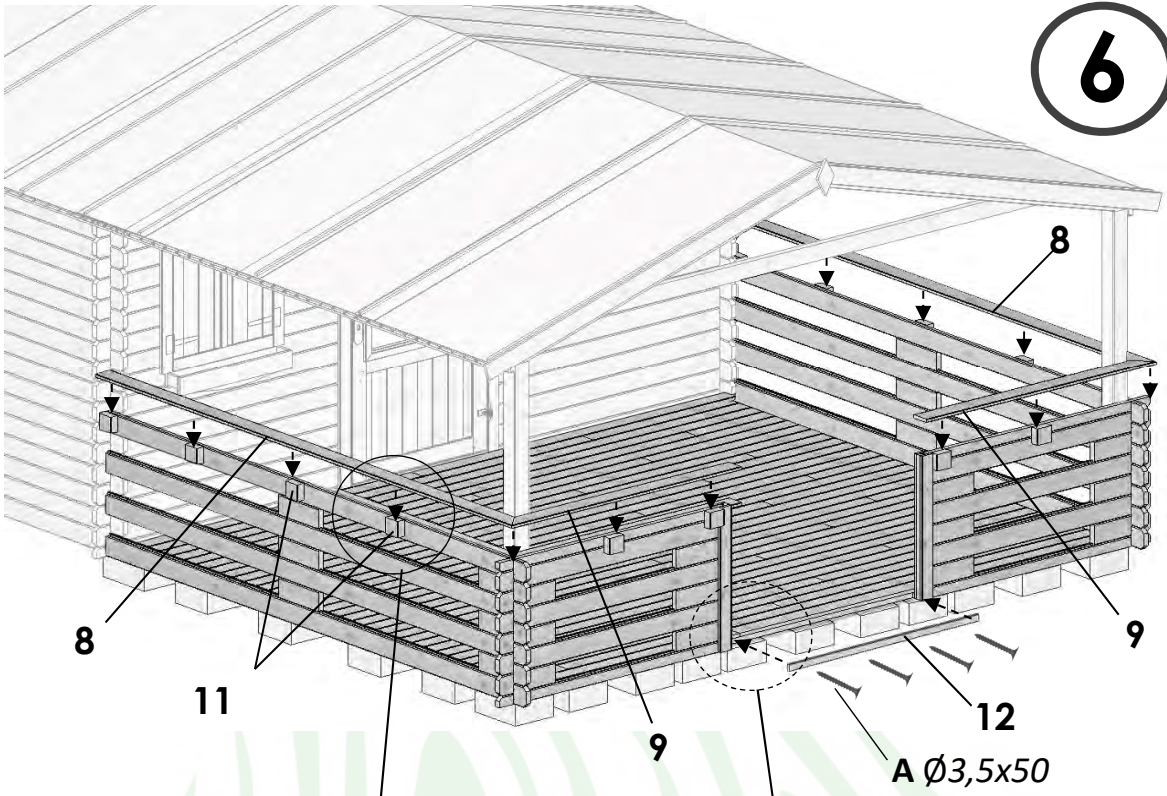

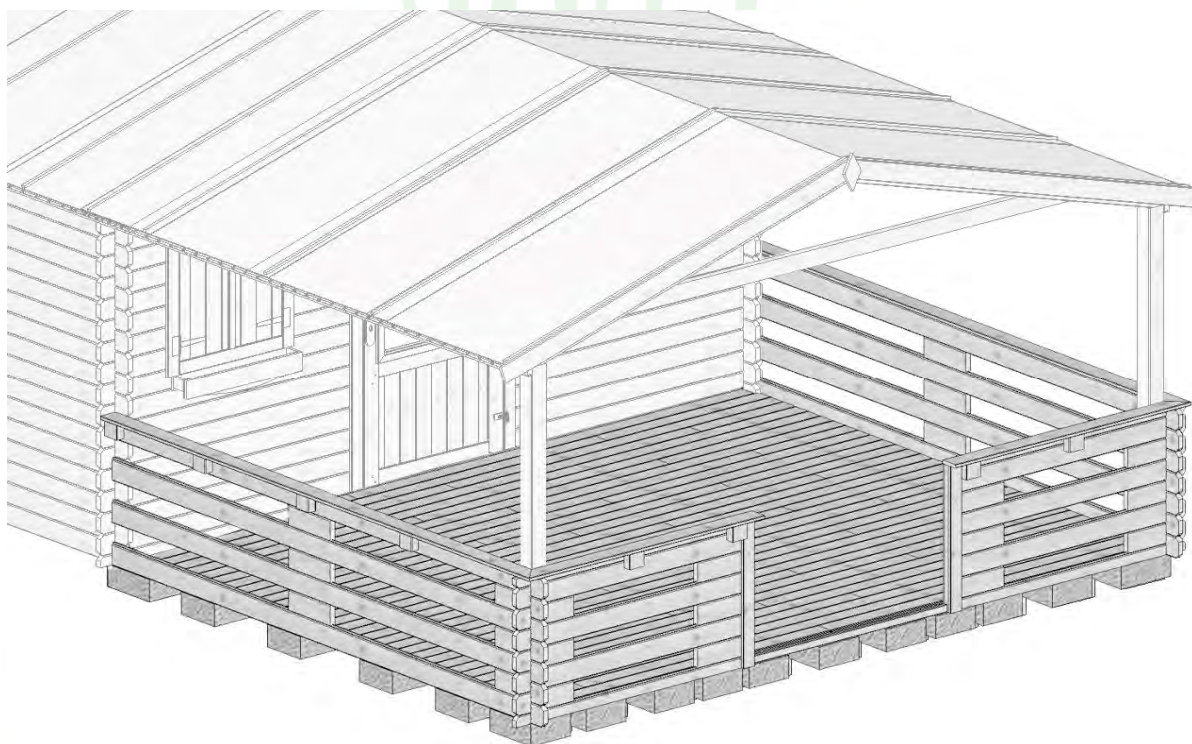

# MONTAŻ PODŁOGA 3m<sup>2</sup>

BI

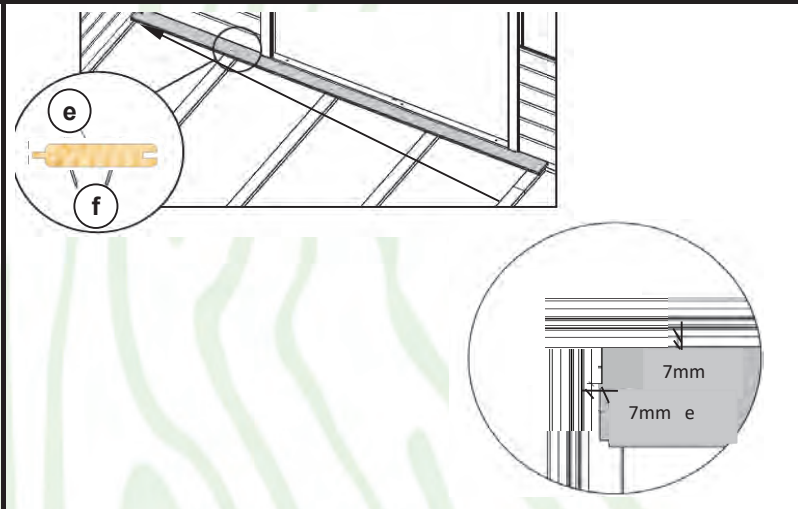
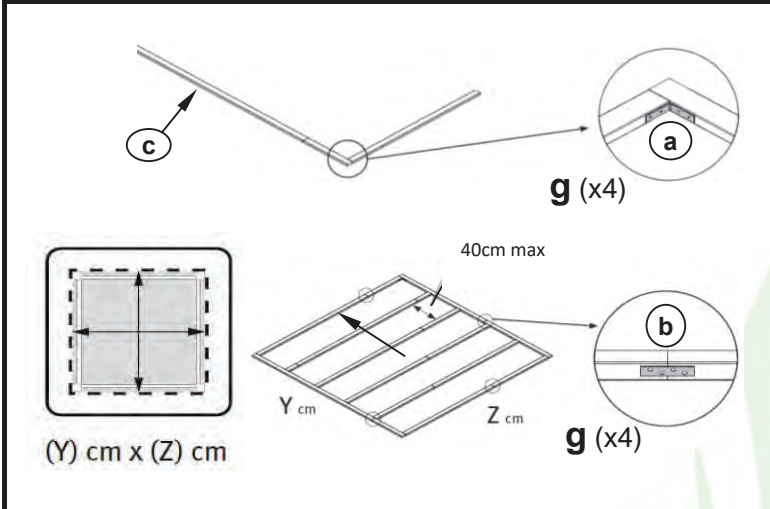

a		x2
b		x3
c		x4
d		x2
e		x14
f		x200
g		x20

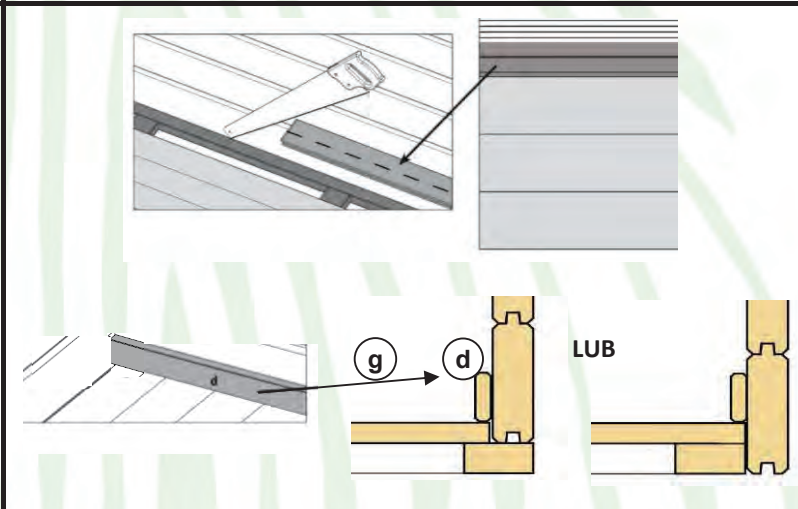
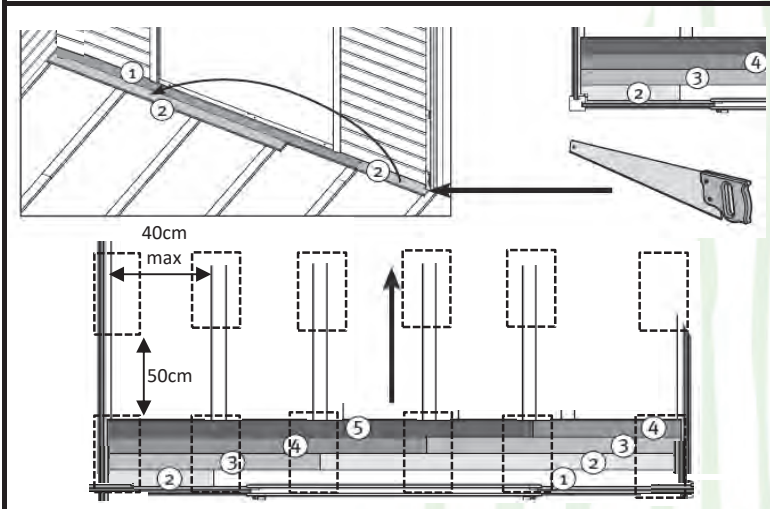







UŁOŻENIE BLOCZKÓW BETONOWYCH POD KONSTRUKCJĄ PODŁOGI/DOMKU

--	--	--	--	--

No **109443**

## PODŁOGA - 19 mm 3m<sup>2</sup>

LP	NAZWA - ELEMENTY	[mm]	[mm]	[m]	[szt.]
1	 deska podłogi pióro wpust dachowa	19	99	2,4	14
2	 listwa przypodłogowa (profil faszolki)	13	45	2,4	2
3	 legar podłogi - IMPREGNOWANY	28	58	2,4	4
LP	OKUCIA PODŁOGI	[mm]		[szt.]	
1	gwoździe 	2,0x40		200	
2	plaskownik łącznik z 4 otworami 	12x100		3	
3	kątownik 	12x65x65		2	
4	wkręt do drewna 	3,5x30		20	

DATA:

podpis osób pakujących .....

No **109443**